



Sorensen

M130/M131

Ethernet Option

for DLM600 and DCS Series
Programming Manual

About AMETEK

AMETEK Programmable Power, Inc., a Division of AMETEK, Inc., is a global leader in the design and manufacture of precision, programmable power supplies for R&D, test and measurement, process control, power bus simulation and power conditioning applications across diverse industrial segments. From bench top supplies to rack-mounted industrial power subsystems, AMETEK Programmable Power is the proud manufacturer of Elgar, Sorensen, California Instruments and Power Ten brand power supplies.

AMETEK, Inc. is a leading global manufacturer of electronic instruments and electromechanical devices with annualized sales of \$2.5 billion. The Company has over 11,000 colleagues working at more than 80 manufacturing facilities and more than 80 sales and service centers in the United States and around the world.

Trademarks

AMETEK is a registered trademark of AMETEK, Inc. Sorensen is a trademark owned by AMETEK, Inc. Other trademarks, registered trademarks, and product names are the property of their respective owners and are used herein for identification purposes only.

Notice of Copyright

M130/M131 Ethernet Option for DLM600 and DCS Series Programming Manual © 2002 AMETEK Programmable Power, Inc. All rights reserved.

Exclusion for Documentation

UNLESS SPECIFICALLY AGREED TO IN WRITING, AMETEK PROGRAMMABLE POWER, INC. ("AMETEK"):

- (a) MAKES NO WARRANTY AS TO THE ACCURACY, SUFFICIENCY OR SUITABILITY OF ANY TECHNICAL OR OTHER INFORMATION PROVIDED IN ITS MANUALS OR OTHER DOCUMENTATION.
- (b) ASSUMES NO RESPONSIBILITY OR LIABILITY FOR LOSSES, DAMAGES, COSTS OR EXPENSES, WHETHER SPECIAL, DIRECT, INDIRECT, CONSEQUENTIAL OR INCIDENTAL, WHICH MIGHT ARISE OUT OF THE USE OF SUCH INFORMATION. THE USE OF ANY SUCH INFORMATION WILL BE ENTIRELY AT THE USER'S RISK, AND
- (c) REMINDS YOU THAT IF THIS MANUAL IS IN ANY LANGUAGE OTHER THAN ENGLISH, ALTHOUGH STEPS HAVE BEEN TAKEN TO MAINTAIN THE ACCURACY OF THE TRANSLATION, THE ACCURACY CANNOT BE GUARANTEED. APPROVED AMETEK CONTENT IS CONTAINED WITH THE ENGLISH LANGUAGE VERSION, WHICH IS POSTED AT WWW.PROGRAMMABLEPOWER.COM.

Date and Revision

December 2008 Revision E

Part Number

M362797-03

Contact Information

Telephone: 800 733 5427 (toll free in North America)
858 450 0085 (direct)
Fax: 858 458 0267
Email: sales@programmablepower.com
service@programmablepower.com
Web: www.programmablepower.com

This page intentionally left blank.

Important Safety Instructions

Before applying power to the system, verify that your product is configured properly for your particular application.

	Hazardous voltages may be present when covers are removed. Qualified personnel must use extreme caution when servicing this equipment. Circuit boards, test points, and output voltages also may be floating above (below) chassis ground.
	The equipment used contains ESD sensitive parts. When installing equipment, follow ESD Safety Procedures. Electrostatic discharges might cause damage to the equipment.

Only *qualified personnel* who deal with attendant hazards in power supplies, are allowed to perform installation and servicing.

Ensure that the AC power line ground is connected properly to the Power Rack input connector or chassis. Similarly, other power ground lines including those to application and maintenance equipment *must* be grounded properly for both personnel and equipment safety.

Always ensure that facility AC input power is de-energized prior to connecting or disconnecting any cable.

In normal operation, the operator does not have access to hazardous voltages within the chassis. However, depending on the user's application configuration, **HIGH VOLTAGES HAZARDOUS TO HUMAN SAFETY** may be normally generated on the output terminals. The customer/user must ensure that the output power lines are labeled properly as to the safety hazards and that any inadvertent contact with hazardous voltages is eliminated.

Guard against risks of electrical shock during open cover checks by not touching any portion of the electrical circuits. Even when power is off, capacitors may retain an electrical charge. Use safety glasses during open cover checks to avoid personal injury by any sudden component failure.

Neither AMETEK Programmable Power Inc., San Diego, California, USA, nor any of the subsidiary sales organizations can accept any responsibility for personnel, material or inconsequential injury, loss or damage that results from improper use of the equipment and accessories.

SAFETY SYMBOLS

	WARNING Risk of Electrical Shock		CAUTION Refer to Accompanying Documents
	Off (Supply)		Direct Current (DC)
	Standby (Supply)		Alternating Current (AC)
	On (Supply)		Three-Phase Alternating Current
	Protective Conductor Terminal		Earth (Ground) Terminal
	Fuse		Chassis Ground

This page intentionally left blank.

Product Family: M130/M131 Ethernet Option

Warranty Period: Five Years

WARRANTY TERMS

AMETEK Programmable Power, Inc. ("AMETEK"), provides this written warranty covering the Product stated above, and if the Buyer discovers and notifies AMETEK in writing of any defect in material or workmanship within the applicable warranty period stated above, then AMETEK may, at its option: repair or replace the Product; or issue a credit note for the defective Product; or provide the Buyer with replacement parts for the Product.

The Buyer will, at its expense, return the defective Product or parts thereof to AMETEK in accordance with the return procedure specified below. AMETEK will, at its expense, deliver the repaired or replaced Product or parts to the Buyer. Any warranty of AMETEK will not apply if the Buyer is in default under the Purchase Order Agreement or where the Product or any part thereof:

- is damaged by misuse, accident, negligence or failure to maintain the same as specified or required by AMETEK;
- is damaged by modifications, alterations or attachments thereto which are not authorized by AMETEK;
- is installed or operated contrary to the instructions of AMETEK;
- is opened, modified or disassembled in any way without AMETEK's consent; or
- is used in combination with items, articles or materials not authorized by AMETEK.

The Buyer may not assert any claim that the Products are not in conformity with any warranty until the Buyer has made all payments to AMETEK provided for in the Purchase Order Agreement.

PRODUCT RETURN PROCEDURE

1. Request a Return Material Authorization (RMA) number from the repair facility (**must be done in the country in which it was purchased**):
 - **In the USA**, contact the AMETEK Repair Department prior to the return of the product to AMETEK for repair:
Telephone: 800-733-5427, ext. 2295 or ext. 2463 (toll free North America)
858-450-0085, ext. 2295 or ext. 2463 (direct)
 - **Outside the United States**, contact the nearest Authorized Service Center (ASC). A full listing can be found either through your local distributor or our website, www.programmablepower.com, by clicking Support and going to the Service Centers tab.
2. When requesting an RMA, have the following information ready:
 - Model number
 - Serial number
 - Description of the problem

NOTE: Unauthorized returns will not be accepted and will be returned at the shipper's expense.

NOTE: A returned product found upon inspection by AMETEK, to be in specification is subject to an evaluation fee and applicable freight charges.

This page intentionally left blank.

CONTENTS

SECTION 1 FEATURES, FUNCTIONS, AND SPECIFICATIONS	1-1
1.1 Introduction.....	1-1
1.2 Features and Functions.....	1-2
1.2.1 Features.....	1-2
1.2.2 Programmable Functions.....	1-3
1.2.3 Readback Functions.....	1-3
1.3 Specifications.....	1-3
1.3.1 Ethernet/LAN Configuration.....	1-3
1.3.2 Ethernet Configuration Factory Defaults.....	1-4
1.3.3 Programming Resolution.....	1-4
1.3.4 Programming Accuracy.....	1-4
1.3.5 Readback Resolution.....	1-5
1.3.6 Readback Accuracy.....	1-5
SECTION 2 CONFIGURATION	2-1
2.1 Setup Procedure.....	2-1
2.1.1 M130 Network Setup Using DHCP.....	2-1
2.1.2 M130 Network Setup Using Auto-IP.....	2-2
2.1.3 M130 Network Setup Using the Serial COM Port.....	2-3
2.1.4 M130 Network Setup Using Web Browser.....	2-4
2.2 Rear Panel.....	2-5
2.2.1 M130 (Master) Option.....	2-5
2.2.2 M131 (Slave) Option.....	2-6
2.2.3 Configuration Switch.....	2-8
2.2.4 Remote/Local Selection.....	2-9
2.3 External User Control Signal Connector.....	2-10

2.4	Programming Via Ethernet.....	2-12
2.4.1	Communication Methods	2-12
2.4.2	Raw Socket Interface	2-12
2.4.3	VXI-11 Protocol	2-12
2.4.4	Web Server	2-12
2.4.5	Troubleshooting	2-29
2.5	Remote Programming Via RS-232.....	2-30
2.6	Extended Interface Bus (EIB) with the M131 Option.....	2-31

SECTION 3 IEEE 488.2 AND SCPI COMMAND OPERATION..... 3-1

3.1	Introduction	3-1
3.2	IEEE-488.2 Register Definitions.....	3-1
3.2.1	SCPI Status Byte	3-1
3.2.2	Standard Event Status Register (ESR)	3-2
3.2.3	Protection Condition and Protection Event Status Registers	3-3
3.2.4	Operation Status and Questionable Status Registers.....	3-4
3.2.5	Error/Event Queue	3-4
3.2.6	Serial Poll Operation	3-6
3.3	IEEE-488.2 and SCPI Conformance Information	3-7
3.3.1	Parameter Definitions.....	3-7
3.3.2	Units.....	3-7
3.3.3	Conventions	3-8
3.3.4	Queries.....	3-8
3.4	IEEE-488.2 Common Command Subsystem.....	3-9
3.5	CALIBRATION SCPI Command Subsystem.....	3-11
3.5.1	CALIBRATION SCPI Command Summary.....	3-11
3.5.2	CALIBRATION SCPI Command Reference.....	3-12
3.6	MEASURE SCPI Command Subsystem.....	3-15
3.6.1	MEASURE SCPI Command Summary	3-15
3.6.2	MEASURE SCPI Command Reference.....	3-15
3.7	OUTPUT SCPI Command Subsystem.....	3-16
3.7.1	OUTPUT SCPI Command Summary	3-16
3.7.2	OUTPUT SCPI Command Reference.....	3-16
3.8	SOURCE SCPI Command Subsystem	3-17
3.8.1	SOURCE SCPI Command Summary.....	3-17
3.8.2	SOURCE SCPI Command Reference	3-18
3.8.3	THE RAMP FUNCTION	3-21

3.9	STATUS SCPI Command Subsystem.....	3-22
3.9.1	STATUS SCPI Command Summary	3-22
3.9.2	STATUS SCPI Command Reference	3-22
3.10	SYSTEM SCPI Command Subsystem	3-24
3.10.1	SYSTEM SCPI Command Summary.....	3-24
3.10.2	SYSTEM SCPI Command Reference.....	3-25
3.11	TRIGGER SCPI Command Subsystem.....	3-29
3.11.1	TRIGGER SCPI Command Summary	3-29
3.11.2	TRIGGER SCPI Command Reference	3-29
3.12	Examples of Using the SCPI Commands	3-30
 SECTION 4 CALIBRATION		4-1
4.1	Introduction.....	4-1
4.2	Setup for Calibration	4-2
4.3	Voltage Programming Calibration.....	4-3
4.4	Voltage Measurement/Readback Calibration	4-5
4.5	Overvoltage Protection Programming.....	4-6
4.6	Current Programming Calibration	4-7
4.7	Current Measurement/Readback Calibration	4-9
4.8	Update of Non-Volatile Calibration Dates.....	4-10
 SECTION 5 OPERATION WITH M131 OPTION		5-1
5.1	Introduction.....	5-1
5.2	Configuration	5-1
5.3	System Installation.....	5-3
5.4	RS-485 Interface.....	5-4
5.5	Programming the M131 Unit (Example)	5-4
 LIST OF FIGURES		
	Figure 2-1. Power Supply's Home Page (DLM600 Series shown here).....	2-2
	Figure 2-2. Typical Rear Panel of M130 Ethernet Option for DLM600.....	2-5
	Figure 2-3. Typical Rear Panel of M130 Option for DCS1k and DCS1.2k	2-5
	Figure 2-4. Typical Rear Panel of M130 Option for DCS3k.....	2-6
	Figure 2-5. Typical Rear Panel of M131 Ethernet Option for DLM600.....	2-6
	Figure 2-6. Typical Rear Panel of M131 Ethernet Option for DCS1k and DCS1.2k.....	2-6
	Figure 2-7. Typical Rear Panel of M131 Ethernet Option for DCS3k.....	2-7
	Figure 2-8. DLM 600W Configuration Switch for the M130 Option	2-8
	Figure 2-9. DCS Configuration Switch for the M130 Option.....	2-8

Figure 2-10. External User Connector Designation (8-pin Molex)	2-10
Figure 2-11. Example of Open Collector, TTL Input, and Relay Output Circuits	2-11
Figure 2-12. DLM Web Page Banner.....	2-13
Figure 2-13. DCS Web Page Banner.....	2-13
Figure 2-14. Login Window	2-14
Figure 2-15. DLM Home Page	2-14
Figure 2-16. DCS Home Page	2-15
Figure 2-17. DLM IP Configuration Page.....	2-16
Figure 2-18. DCS IP Configuration Page.....	2-16
Figure 2-19. Settings Page	2-19
Figure 2-20. Alert Message for Save Settings	2-21
Figure 2-21. Status Page	2-22
Figure 2-22. Security Page	2-24
Figure 2-23. Add New User Window from Security Page	2-25
Figure 2-24. Edit Existing User Window from Security Page.....	2-26
Figure 2-25. Channel Allocation Window from Security Page	2-27
Figure 2-26. Slave Information Page	2-28
Figure 2-27. RS-232 Rear Panel RJ-11 Connector Pinout.....	2-30
Figure 2-28. M130 to PC RS-232 Connection (RJ-11 to DB-9)	2-30
Figure 2-29. EIB (RS485) Rear Panel RJ-11 Connector Pinout.....	2-31
Figure 2-30. M130 to M131 EIB Connection (RJ-11 to RJ-11)	2-31
Figure 5-1. DLM600W Configuration for M131 set to Channel 2.....	5-1
Figure 5-2. Switch Configuration for M6 or M131 set to Channel 8	5-2
Figure 5-3. RS-485 System Interconnection with Two Auxiliaries	5-3
Figure 5-4. M131 Rear Panel RS-485 Connectors Pinout.....	5-4

LIST OF TABLES

Table 2-1 Remote/Local Switch	2-9
Table 2-2 Remote Mode Power-on Conditions.....	2-9
Table 2-3 External User Control Signal Connector Pinout.....	2-10
Table 3-1 SCPI Status Byte	3-2
Table 3-2 Standard Event Status Register	3-3
Table 3-3 Protection Condition and Event Status Registers.....	3-3
Table 3-4 SCPI Error Codes	3-4
Table 3-5 Parameter Definitions	3-7
Table 3-6 M130 Units.....	3-7
Table 3-7 SOURce[n]:STATus:BLOCK? "Status Flags" Register	3-21
Table 3-8 System Fault Registers.....	3-28
Table 5-1 Definitions of S1 Switch Settings	5-2

SECTION 1

FEATURES, FUNCTIONS, AND SPECIFICATIONS

1.1 INTRODUCTION

This manual covers the M130 and M131 Remote Programming Ethernet Interface Options for the DLM600 Series and the DCS Series power supplies. The M130 (master interface configuration) and M131 (slave configuration) options enable you to operate your Sorensen power supply from a computer via Ethernet IEEE-802.3 or RS-232 communication protocols, or with SCPI-compatible language, allowing full remote programming control and monitoring of your power supply. The M130 can control up to 30 auxiliary (slave) power supplies

In addition to controlling power supplies configured with the M131 (Ethernet) slave option, the M130 master can control power supplies configured with the M85 (GPIB/RS232) slave option, which uses the same RS485-based Extended Interface Bus (EIB) for master/slave control; whereas, a GPIB master (M9x) can control only GPIB slaves (M85). This means that a single Sorensen DLM600 or DCS power supply configured with the M130 option, can control any Sorensen power supply (DLM600, DCS 1k, DCS 1.2k, DCS 3k), in any combination of M131 and/or M85 slave configuration options, up to as many as 30 power supplies total.

A final important point is that the M130 / M131 Ethernet options are **LXI™** (LAN eXtensions for Instrumentation) class C compliant. LXI™ is an instrumentation platform based on industry-standard Ethernet technology designed to provide ease of integration by modularity, flexibility and performance.

1.1.1 MINIMUM SYSTEM REQUIREMENTS

The minimum software and equipment requirements to operate your Sorensen Ethernet product depend on whether it is connected directly to your PC or connected to the Internet or to a Local Area Network (LAN).

PC Connection

To operate your Sorensen Ethernet product connected directly to a PC (no Internet or LAN connection) you will need:

- Pentium-based laptop or desktop computer running Microsoft Windows XP
- Ethernet based Network Interface Card (NIC) or built-in port capable of 10/100 MBit operation
- CAT 5 cable Ethernet crossover cable
- Microsoft Internet Explorer version 6.0 or later
- Sun Microsystems Java Runtime Environment

Internet or LAN Connection

To operate your Sorensen Ethernet product connected to the Internet or a LAN you will need:

- Pentium-based laptop or desktop computer running Microsoft Windows XP
- Ethernet based Network Interface Card (NIC) or built-in port capable of 10/100 MBit operation
- Appropriate Ethernet modem for Internet connection, or
- Switch or hub (Linksys brand strongly recommended) for LAN connection
- Standard CAT 5 Ethernet interconnect cable
- Microsoft Internet Explorer version 6.0 or later
- Sun Microsystems Java Runtime Environment

1.2 FEATURES AND FUNCTIONS

1.2.1 FEATURES

- Ethernet/LAN connectivity, 10/100base-T compatible
- Fully **LXI**[™] (LAN eXtensions for Instrumentation) class C compliant
- Built-in Web Server for direct control using Internet Explorer 6.0 or higher
- 16-bit programming and 16-bit readback of voltage and current
- Programmable overvoltage protection with reset
- SCPI compliant command set
- User-programmable signals including Local/Remote Sense, External Polarity, and Disconnect Relay Drive
- User selectable Constant-Voltage/Constant-Current or Foldback mode, with reset
- Voltage Ramp and Current Ramp functions
- Field-upgradeable firmware via RS-232
- Attachment of up to 30 supplies equipped with the M131 or M85 option via EIB interface, for a total of 31 supplies controlled through one IP address
- Full calibration through software control

- Rear panel Ethernet/IEEE-802.3 and RS-232 control interface
- Rear panel User Control Signal interface
- Rear panel configuration switch

1.2.2 PROGRAMMABLE FUNCTIONS

- Output voltage and current
- Soft limits for voltage and current
- Overvoltage protection
- Output enable/disable
- Maskable fault interrupt
- Hold and trigger
- External relay control
- Full calibration

1.2.3 READBACK FUNCTIONS

- Measured voltage and current
- Voltage and current settings
- Soft voltage and current limits
- Overvoltage protection setting
- Status and Accumulated Status registers
- Programming error codes
- Fault codes
- Manufacturer, power supply model, and firmware version identification

1.3 SPECIFICATIONS

(SUBJECT TO CHANGE WITHOUT NOTICE)

1.3.1 ETHERNET/LAN CONFIGURATION

- Ethernet IEEE 802.3 compliant
- Medium 10/100 base-T
- Connection Monitoring Media Sense supported
- Protocol TCP/IP, IPV4
- ICMP (ping server) Enable (default)/Disable
- IP Address Assignment Automatic via DHCP (Primary default), Static, or Automatic Private IP Addressing (Auto-IP, Secondary default)
- VXI-11 Discovery Supported
- Security Password protected access, and selective permissions for each user

1.3.2 ETHERNET CONFIGURATION FACTORY DEFAULTS

PARAMETER	DEFAULT
Host Name	S-Dxx<base model>-<last four digits of serial number>
Description	Sorensen Power Supply Dxx<base model>
IP Address	DHCP-acquired (Primary default*) If DHCP absent, assigned via Auto-IP (Secondary default*)
IP Addressing mode	DHCP-acquired (Primary default*)
Subnet Mask	DHCP-acquired (Primary default*) If DHCP absent, assigned via Auto-IP (Secondary default*)
Gateway	0.0.0.0
DNS Server	0.0.0.0
Listening Port	9221
User ID	admin
Password	password
Ping Echo	On

* The Ethernet interface provides the opportunity to set both a Primary and a Secondary IP configuration in the IP Configuration page (Section 2.4.4). If the Primary fails, the system defaults to the Secondary configuration. However, both setting DHCP-acquired *and* selecting “Auto IP Enabled” together in the Primary configuration, prevents the power supply from trying the Secondary configuration. Please see “IP Configuration” in Section 2.4.4 for more detail.

1.3.3 PROGRAMMING RESOLUTION

	DLM	DCS
Voltage	0.002% of full scale	0.002% of full scale
Current	0.002% of full scale	0.002% of full scale
Overvoltage Protection	0.002% of full scale (full scale is 110% of max output voltage.)	0.002% of full scale (full scale is 110% of max output voltage.)

1.3.4 PROGRAMMING ACCURACY

	DLM600	DCS
Voltage	± (0.1% of maximum output voltage)	± (0.1% + 0.1% of full scale)
Current	± (0.25% of full scale output current)	± (0.1% + 0.4% of full scale)
Overvoltage Protection	± (0.5% of max output voltage)	± (0.5% + 0.5% of full scale) (full scale 110% of max. output voltage)

1.3.5 READBACK RESOLUTION

	DLM600	DCS
Voltage	0.002% of full scale	0.02% of full scale
Current	0.002% of full scale	0.02% of full scale

1.3.6 READBACK ACCURACY

	DLM600	DCS
Voltage	$\pm (0.1\% \text{ of full scale output voltage})$	$\pm (0.1\% + 0.15\% \text{ of maximum output voltage})$
Current*	$\pm (0.25\% \text{ of full scale output current})^*$	$\pm (0.1\% + 0.4\% \text{ of maximum output current})$

* After 30 minutes operation with fixed line, load, and temperature.

Note: Refer to the applicable power supply manual (DLM600 or DCS) for effects of line regulation, load regulation, and temperature on accuracy specifications.

This page intentionally left blank.

SECTION 2 CONFIGURATION

The M130 is installed into the supply at the factory. Use the Setup Procedure described below to configure the M130 for your system and application.

2.1 SETUP PROCEDURE

There are four methods of setting the IP address of the unit, each of which is described in the subsections that follow:

- Set an IP address through DHCP (Primary default).
- If DHCP is not available, the unit can assign itself an IP address in the Auto-IP (dynamic link local addressing) range (Secondary default).
- Use the serial communications port to manually assign an IP address.
- Set the IP address through the Web page interface.

NOTE: The M130 Ethernet Option has been designed and tested to be fully compatible with Microsoft Internet Explorer 6.0. This is the only browser supported by Elgar Electronics Corporation (EEC) in its Ethernet-based products. Earlier versions of Explorer (or browsers by other companies) may or may not work correctly, and as such, are not supported by EEC.

2.1.1 M130 NETWORK SETUP USING DHCP

Before beginning this procedure, get access to the DHCP server or see the network administrator to get the IP address assigned to the power supply.

NOTE: The power supply is VXI-11 compliant, so even without access to the DHCP server, it is still possible to discover the IP address assigned to the power supply with programs such as Agilent's I/O Library Suite or National Instrument's NI-VISA.

1. Start with the power supply in the power-off state.
2. Connect a RJ-45 network cable from the power supply to the network with the DHCP server.
3. Power on the power supply and allow the power supply to perform its initialization.

4. Identify the IP address assigned to the power supply by accessing the DHCP server, asking your network administrator, or discovering it with a VXI-11 compliant discover program.
5. The M130 Ethernet hardware is now configured. Open your Web browser and enter the IP address of the power supply to view the Home page of the power supply.

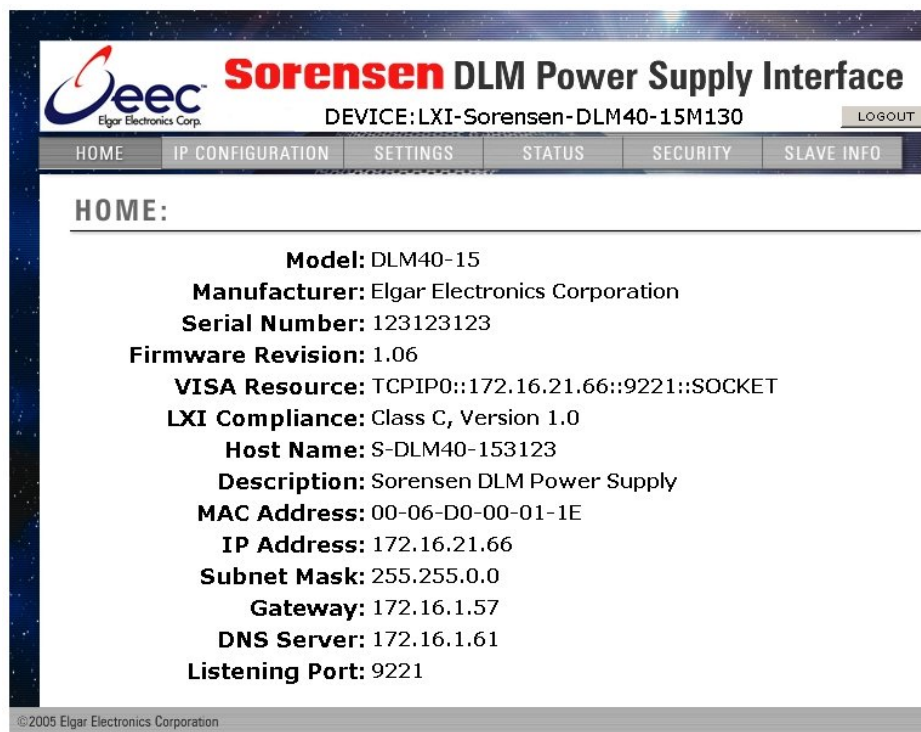

Figure 2-1. Power Supply's Home Page (DLM600 Series shown here)

2.1.2 M130 (MASTER) NETWORK SETUP USING AUTO-IP

For this method, use a VXI-11 compliant discovery program such as Agilent's I/O Library Suite or National Instrument's NI-VISA to discover the IP address assigned to the power supply. The power supply will assign itself an IP address in the IP address range from 169.254.0.1 to 169.254.255.254 with a subnet mask of 255.255.0.0.

NOTE: When connecting your Sorensen Master unit to a network, Elgar strongly recommends using Linksys® hubs or switches, which have undergone extensive compatibility testing with the M130 interface.

1. Start with the power supply in the power-off state.
2. Connect a crossover cable from the power supply directly to your PC.
3. If the PC is already configured to obtain an IP address automatically, skip to Step 4. Otherwise:

- a. In Windows click **Start, Settings, Control Panel**.
 - b. Click open **Network Connections**. (For XP, if in the Category View, click Network and Internet Connections, and then Network Connections).
 - c. In the Network Connections window, right click the icon for the network adapter used to connect to the power supply, and click **Properties**.
 - d. Find the TCP/IP protocol item under the **Configuration** tab (for XP: find the item under the **General** tab), and click **Properties**. Select **Obtain an IP Address Automatically**.
 - e. Click **OK** to save the change.
 - f. Click **OK** again to apply the settings to the network adapter.
4. In Windows, click **Start**, and then **Run...**
 5. In the Run window, type "ipconfig /release" and click **OK**.
 6. Again click **Start**, and then **Run...**
 7. In the Run window, type "ipconfig /renew" and click **OK**. Your PC will assign itself an IP address in the Auto-IP range.
 8. Power on the power supply and allow the power supply to perform its initialization.
 9. Identify the IP address assigned to the power supply by discovering it with a VXI-11 compliant discover program.
 10. Continue by following the procedure in Section 2.1.4.

NOTE: When Auto-IP assigns an IP address, Web page connections will time out after 5 minutes of inactivity.

2.1.3 M130 NETWORK SETUP USING THE SERIAL COM PORT

1. Connect from the PC COM1 port to the power supply's RS232 port (see Figure 2-2, Figure 2-3 or Figure 2-4 for port location) using a straight-through DB91 to RJ-1 connector. (See Section 2.5 for the wiring diagram).
2. Have ready the IP address (e.g. 192.168.0.200) and subnet mask (e.g., 255.255.255.0) to be assigned to the power supply.
3. Run a serial terminal program, such as HyperTerminal. Set the **baud rate** (bits per second) to 19200, **data bits** to 8, **parity** to none, **stop bits** to 1, **flow control** to none. Establish the connection.
4. Power on the power supply and allow the power supply to perform its initialization. In HyperTerminal, tap the ENTER key a couple of times to clear the input buffer (tapping the ENTER key is also required to clear any errors when using HyperTerminal, rather than tapping the BACKSPACE or DELETE keys).
5. Type SYST:NET:DHCPMODE 0 <enter> to take the Primary configuration out of DHCP mode.

6. Set the IP address by typing **SYST:NET:IP "xxx.xxx.xxx.xxx"** <enter> (where xxx.xxx.xxx.xxx is the new IP address). For example, to set 192.168.0.200 as the IP address, type **SYST:NET:IP "192.168.0.200"** <enter> (note that the format requires a single space after SYST:NET:IP and double quotes around the IP address numbers).
7. Set the subnet mask with "**SYST:NET:MASK xxx.xxx.xxx.xxx**" <enter>.
8. After configuring all settings, verify with the queries, **SYST:NET:IP?** <enter> and **SYST:NET:MASK?** <enter>.
9. Type ***RST**<enter> to perform a power-on reset of the power supply.
10. The M130 Ethernet hardware is now configured. Open your Web browser and enter the assigned IP address of the power supply to view the power supply web page.
11. The power supply is now ready to be plugged into the network.

2.1.4 M130 NETWORK SETUP USING WEB BROWSER

Note: This requires that the PC's IP address be in the same network as the IP address assigned to the power supply. It also requires your Web browser to open the power supply's Home page.

Note: For proper functionality on the Web browser, ensure that Sun Microsystems' *Java Runtime Environment* is installed on the PC. Visit www.java.com to download, after setting the Web browser's Security to enable scripting of Java applets:

1. In the **Tools** menu, select **Internet Options...** and click the **Security** tab.
2. At the bottom of the Security window click **Custom level...**
3. In the **Reset** custom settings drop-down, select **Medium** and click **Reset** and then **OK**).

Now use your Web browser for M130 Network Setup:

In the Web browser's **Address:** field, type **http://xxx.xxx.x.xxx** where xxx.xxx.x.xxx is the power supply's IP address. (See Section 2.4.4 for description and operation information).

2.2 REAR PANEL

2.2.1 M130 (MASTER) OPTION

Figure 2-2 through Figure 2-4 display the pertinent rear panel components of a typical M130 Ethernet option for the DLM600 and the DCS masters.

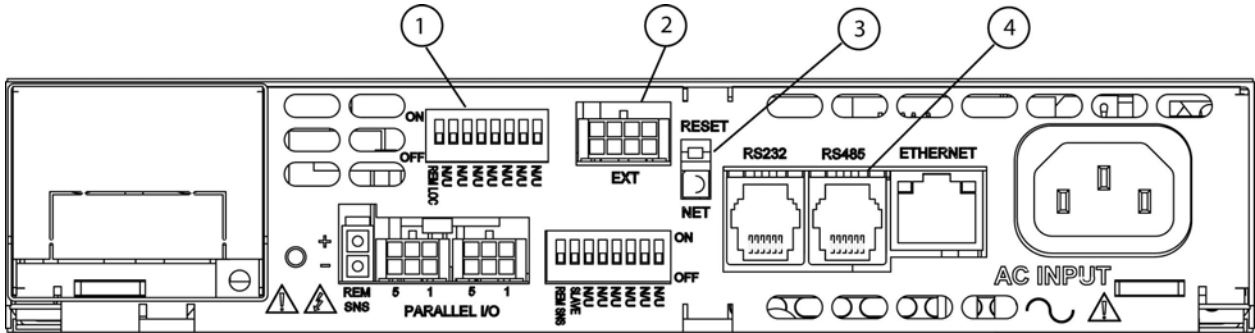

Figure 2-2. Typical Rear Panel of M130 Ethernet Option for DLM600

- 1 – Configuration Switch (for correct settings see Section 2.2.3)
- 2 – External User Control Signal Connector (see Section 2.3)
- 3 – Reset switch and green dual-purpose NET LED.
Reset switch (must be depressed until NET LED begins blinking, which could take five or more seconds) returns configuration parameters to factory default settings (see Section 1.3.2).
NET LED: when solid-lit, indicates Network Connectivity; blinking indicates Instrument ID (See “Instrument ID” under **Settings**, Section 2.4.4). If the LED is off, there is no Ethernet connection found by the power supply.
- 4 – Connections for Ethernet (RJ-45) with built-in 10/100 indicator (on right top of the RJ45 connector) and an Activity indicator (on the left top). Also RJ-11 connectors for RS232 and RS485.

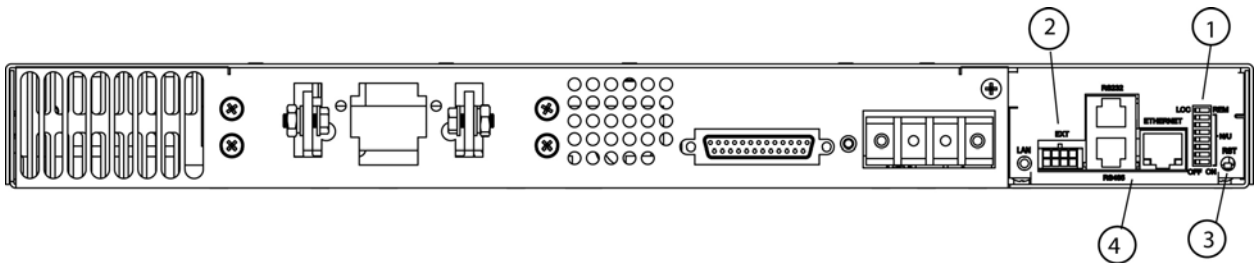

Figure 2-3. Typical Rear Panel of M130 Option for DCS1k and DCS1.2k

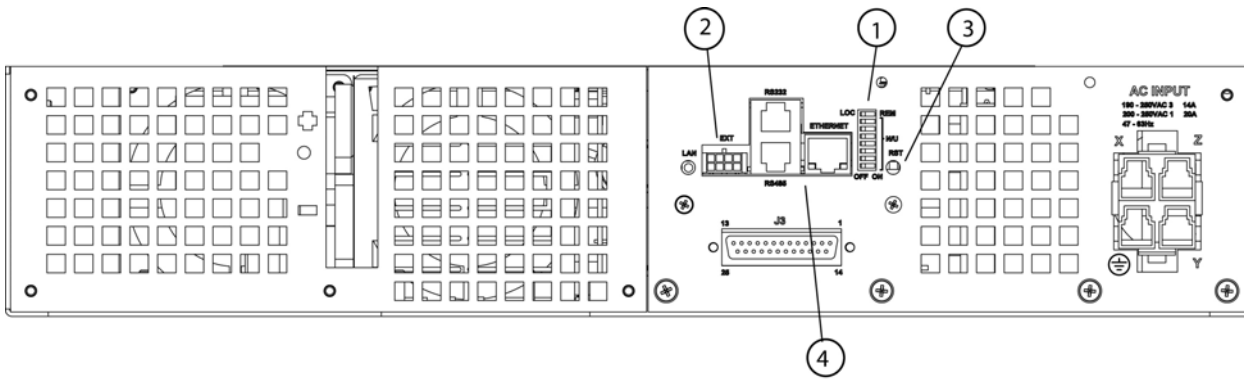

Figure 2-4. Typical Rear Panel of M130 Option for DCS3k

2.2.2 M131 (SLAVE) OPTION

Figure 2-5 through Figure 2-7 display the pertinent rear panel components of a typical M131 Ethernet option for the DLM600 and the DCS slaves.

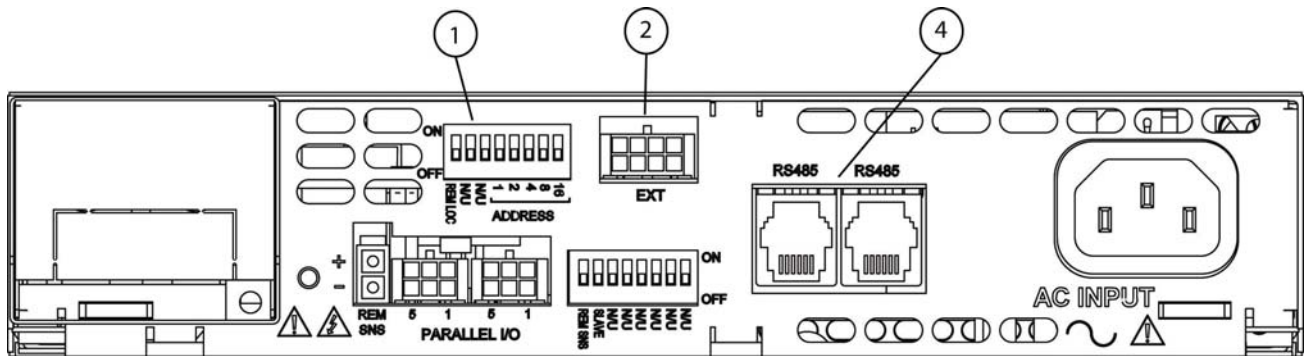

Figure 2-5. Typical Rear Panel of M131 Ethernet Option for DLM600

- 1 – Configuration Switch (for correct settings see Section 5.2)
- 2 – External User Control Signal Connector (see Section 2.3)
- 4 – Connections (RJ-11) for RS485

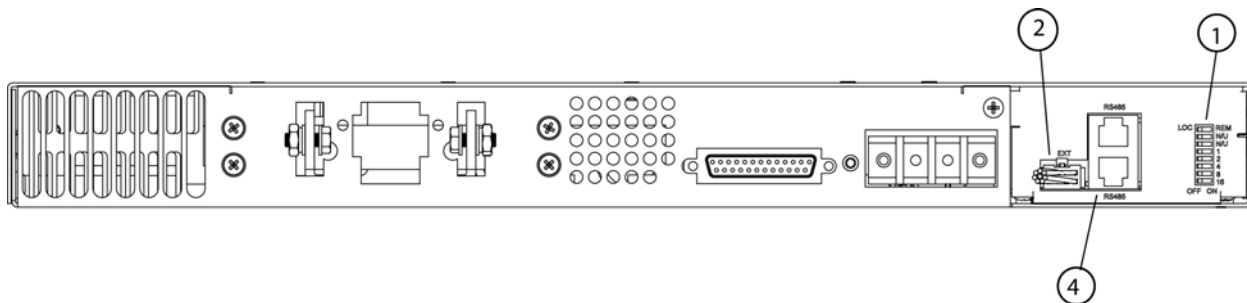

Figure 2-6. Typical Rear Panel of M131 Ethernet Option for DCS1k and DCS1.2k

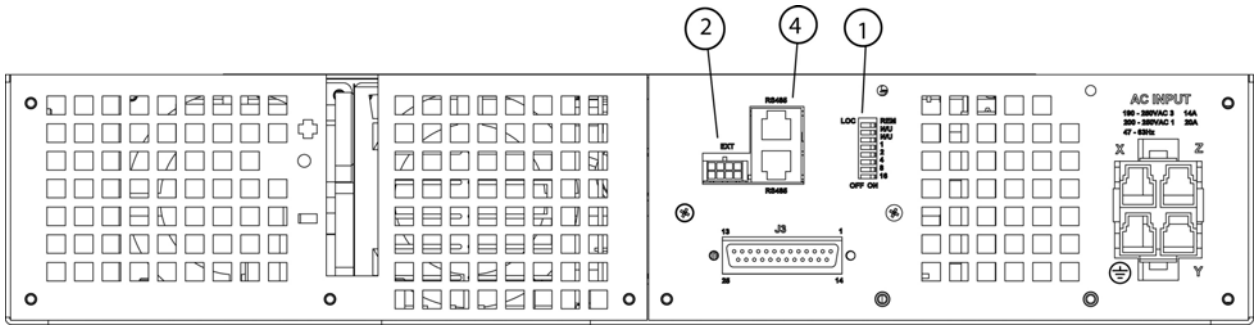

Figure 2-7. Typical Rear Panel of M131 Ethernet Option for DCS3k

2.2.3 CONFIGURATION SWITCH

Use the DIP switch, accessible from the rear panel, to configure the power supply with the installed M130/M131 for the particular system and application in use. The following figures show the DIP switch configuration for the M130, as set up in Section 2.1 (see Section 5.2 for the M131).

Note: On the Ethernet master, the rear panel switch gets set to Remote On, and all remaining switches are disregarded.

Note: Two types of DIP switches are utilized; toggle and rocker. For toggle switches, the shading indicates the position of the toggle switch. For rocker switches, the shading indicates the depressed side.

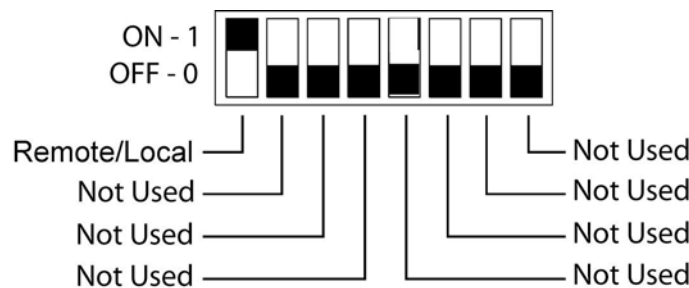

Figure 2-8. DLM 600W Configuration Switch for the M130 Option

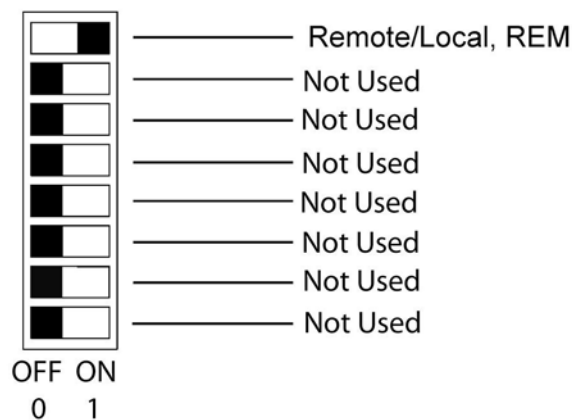

Figure 2-9. DCS Configuration Switch for the M130 Option

2.2.4 REMOTE/LOCAL SELECTION

Set the rear panel Remote/Local switch to select remote or local operation.

Table 2-1 Remote/Local Switch

Switch Position	Description
ON	Remote operation selected.*
OFF	Local operation selected. Front panel control is enabled. Unit will switch to remote operation upon the first Ethernet, or RS-232 command.

* In the ON position, the power hardware and Ethernet card initialize to the remote state at power-on. In addition, front panel control remains disabled regardless of the state of the REN line, or the GTL command. The special SCPI command SYST[n]:LOCAL <on/off> is now permitted as a means to revert to front panel control if desired.

Powering up in remote mode will result in the following operating conditions.

Table 2-2 Remote Mode Power-on Conditions

Condition	Default
Voltage	0 Volts (initial from factory power-on voltage); otherwise, last value saved by SCPI command or by the SAVE SETTINGS button in the Web Settings page. See CAL:INIT:VOLT to change.
Current	0 Amps (initial from factory power-on current); otherwise, last value saved by SCPI command or by the SAVE SETTINGS button in the Web Settings page. See CAL:INIT:CURR to change.
Soft Voltage Limit	Model maximum voltage
Soft Current Limit	Model maximum current
OVP Trip Voltage	Model maximum voltage +10% (initial from factory power-on OVP); otherwise, last value saved by SCPI command or by the SAVE SETTINGS button in the Web Settings page. See CAL:INIT:VOLT:PROT to change.
Delay	0.5 seconds
Foldback Protection	OFF
Output	ON
Hold	OFF
Unmask	NONE
Service Request Capability	OFF

2.3 EXTERNAL USER CONTROL SIGNAL CONNECTOR

An 8-pin Molex connector located at the rear panel provides external auxiliary control signals to increase the user’s operating control of the supply. The mating receptacle is Molex 43025-0800 with 8 female terminals 43030-0003. The Molex terminals accommodate wire sizes from #20 - #24.

The relay outputs, when active, connect the POLARITY, SENSE, and ISOLATION pins of the connector to the relay COMMON pin. The relays are rated at 120VAC/125VDC @ 1A; for DLM600 Series 600W, maximum ratings are 60V(PK), 30VA, and 1A. For DCS 1k, 1.2k, and 3k, the maximum ratings are 250V @ 8A. Any change in output (voltage, current, etc.) initiated by the user from the RS-232, GPIB, or Ethernet interface will generate a 10ms synchronization pulse at the rear panel User Control Signal Connector of the master unit (Sync Signal).

Table 2-3 External User Control Signal Connector Pinout

	Molex Pin	Description
	1	For RS-232/GPIB: FOLDBACK output signal, open collector, active-low. Asserted when in foldback mode. Reserved function for Ethernet interface.
	3	FAULT output signal, open collector, active-low. Asserted when a fault is recorded in the fault register.
	6	POLARITY output signal, relay contacts. Asserted (contacts close to COMMON) when a negative voltage is programmed. (e.g., SOURce:VOLTage -5.0)
	7	ISOLATION output signal, relay contacts. Asserted (contacts close to COMMON) when the output relay is programmed OFF. (e.g., OUTPut:ISOLation OFF)
	8	SENSE output signal, relay contacts. Asserted (contacts close to COMMON) when the sense relay is programmed OFF. (e.g., OUTPut:SENSe OFF)
	2	SHUTDOWN TTL input signal, active-high. Allows the user to immediately shutdown the unit by a TTL input signal.
	5	COMMON for all signals and relay contacts.
	4	For RS-232/GPIB: SYNC output signal, open collector, active-low. Pulsed for 10 ms when a change in the output occurs. Reserved function for Ethernet interface.

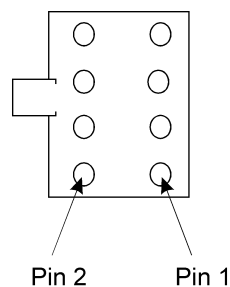

Figure 2-10. External User Connector Designation (8-pin Molex)

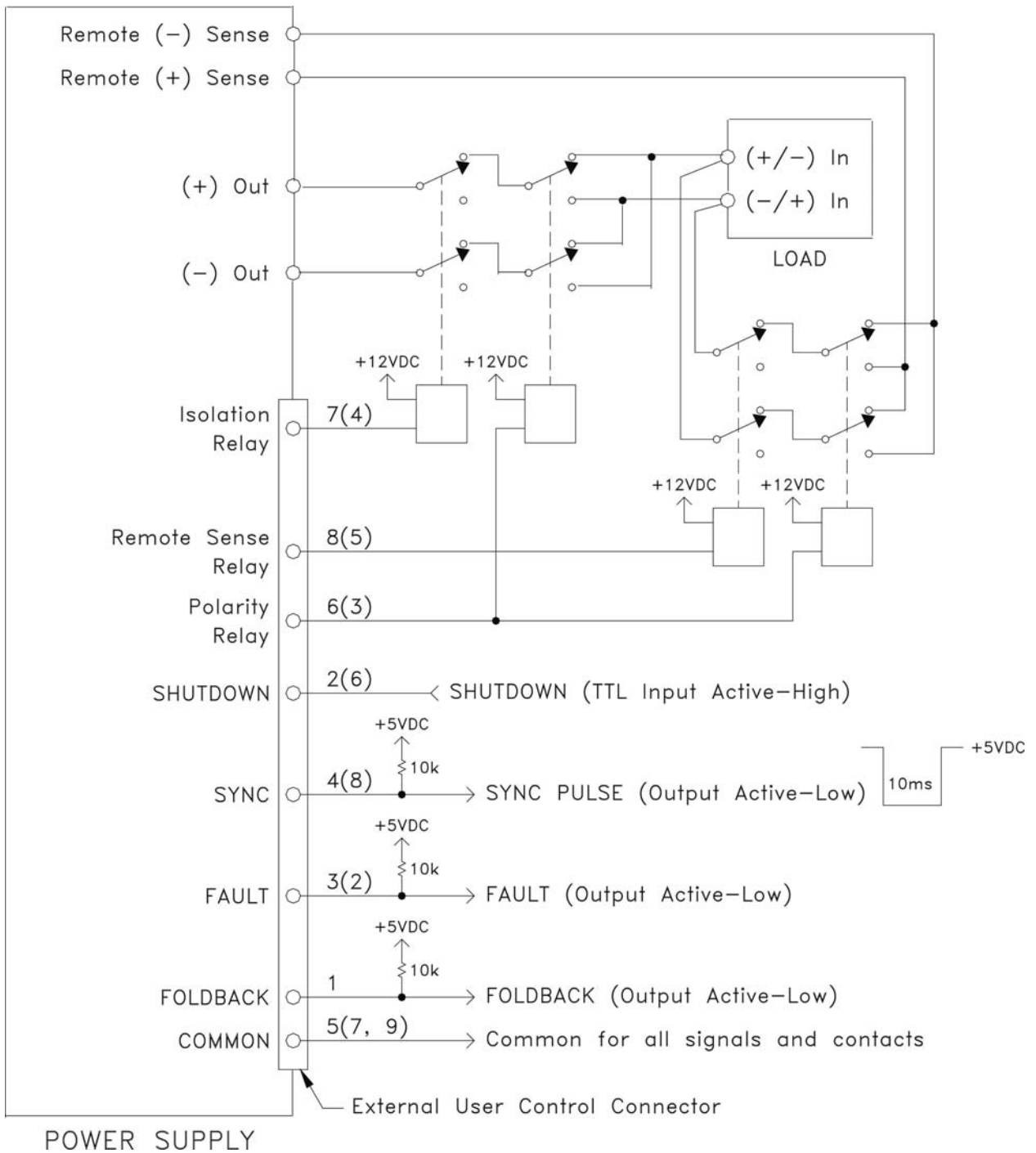

Figure 2-11. Example of Open Collector, TTL Input, and Relay Output Circuits



CAUTION

The relays must not be hot-switched; ensure that the voltage across the relay contacts and the current through them is zero prior to changing the relay states.

2.4 PROGRAMMING VIA ETHERNET

2.4.1 COMMUNICATION METHODS

With the M130 option, there are four basic methods to communicate with the power supply from a PC:

- raw socket interface, sending delimited strings (default delimiter is <LineFeed>)
- application program that utilizes VXI-11 Discovery protocol
- Web browser and the internal Web server, with scripting of Java applets enabled
- RS232C serial interface

2.4.2 RAW SOCKET INTERFACE

The essential components of communicating via a raw socket interface are the socket number, IP address and command delimiter. The default values are: socket = 9221, IP address = 192.168.0.200 (when static IP is enabled), and delimiter = line feed <LF>. All of these items may be changed either via the Web browser (see IP CONFIGURATION, p. 2-16) or RS232C interfaces (see SCPI command section).

For convenience and to comply with the proposed LXI™ standard, the VISA resource name is available on the home page of the power supply's Web server.

2.4.3 VXI-11 PROTOCOL

With programs such as Agilent's I/O Library Suite, or National Instrument's NI-VISA, the VXI-11 protocol allows the power supply to be easily configured in a test system.

2.4.4 WEB SERVER

To communicate with the power supply via the built-in Web server, open a supported Web browser (Internet Explorer 6.0 or higher) and type the IP address of the power supply in the "Address" field. Tap the ENTER key to launch the power supply's Ethernet Web page interface.

Note: *To ensure proper functionality on your Web browser, Sun Microsystems' Java Runtime Environment must be installed on your PC. Visit www.java.com to download. Also, set your Web browser's Security to enable scripting of Java applets. (In the Tools menu, select Internet Options... and click the Security tab. At the bottom of the Security window click Custom level...; in the Reset custom settings drop-down, select Medium and click Reset and then OK).*

Ethernet Web Pages, Overview

The layout of each of the Web pages includes the banner with the heading, “Sorensen DLM (or DCS) Power Supply Interface” along with the device name below and a LOGIN button to the right. Below the banner are six tabs, each linked to its corresponding page. On each page is a title line (title matches tab name). In the title line is an area that frequently displays informational messages as you use the Web interface.

When navigating to the Ethernet Web pages by clicking their tabs, you will find that only two of the pages may be accessed without logging in: HOME (default) and SLAVE INFO; you must log in (click **LOGIN**) before tabbing to the other pages, which allow access by permission only: FULL (Administrator), RW (Read\Write), or R (Read).

- FULL permissions users have access to all pages and all channels and may configure the interface, set and change security settings, allocate channels, control the output of the power supply, send commands, etc.
- RW permissions users may access all pages except SECURITY, and may read and control the output of the power supply for only the channels allocated to them. They are not authorized to make changes on the IP CONFIGURATION page.
- R permission users may read information related only to the channels allocated them, and cannot make any changes or control the output.

Once you have logged in, the LOGIN button becomes a LOGOUT button.

Note: There are few differences between the DCS interface and the DLM interface: their titles and device names in the banner (see Figure 2-12 and Figure 2-13), their specifics in the Home page (see Figure 2-15 and Figure 2-16), and the front panel lockout button in the Settings page (see Figure 2-19) is grayed out for the DCS products. Unless DCS and DLM interfaces are both shown, the following illustrations use only the DLM interface.



Figure 2-12. DLM Web Page Banner



Figure 2-13. DCS Web Page Banner



Figure 2-14. Login Window

HOME

This is the default, information-only page. It displays all of the current information about the master supply that you are connected to (if any slaves are connected, their information is on the SLAVE INFO page):

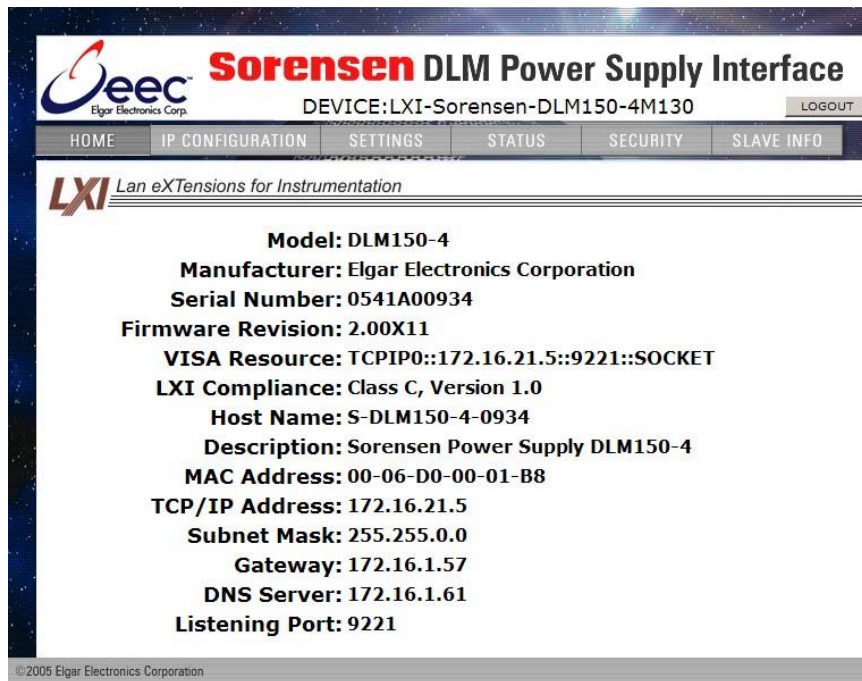

Figure 2-15. DLM Home Page

Model: DCS80-15
Manufacturer: Elgar Electronics Corporation
Serial Number: 0541A00670
Firmware Revision: 2.00X12
VISA Resource: TCPIP0::192.168.0.204::9221::SOCKET
LXI Compliance: Class C, Version 1.0
Host Name: S-DCS80-15-067
Description: Sorensen Power Supply DCS80-15
MAC Address: 00-06-D0-00-01-F4
TCP/IP Address: 192.168.0.204
Subnet Mask: 255.255.0.0
Gateway: 0.0.0.0
DNS Server: 0.0.0.0
Listening Port: 9221

Figure 2-16. DCS Home Page

- The **Model** number, the **Manufacturer**, and the **Serial Number** of your Ethernet power supply
- **Firmware Revision:** the version of the Ethernet firmware that is currently installed for the Master. (See SLAVE INFO page for slave firmware version.)
- **VISA Resource** identifies the specific resource name used to communicate via VISA (Virtual Instrument Software Architecture)
- **LXI™ Compliance:** the version and instrument class of the LXI™ standard with which your power supply is compliant
- **Host Name:** either the default or user-defined, network-unique identity
- **Description:** either the default or user-defined description of the power supply in use (you can change the description to suit your needs, in the CONFIGURATION page)
- **MAC Address:** the power supply Ethernet's unique hardware address
- **IP Address:** your power supply's address actually in use at start-up; can be statically configured, DHCP acquired (default), or Auto-IP assigned (see description for CONFIGURATION page)
- **Subnet Mask:** network segment your power supply is on
- **Gateway:** IP address through which the instrument communicates with systems that are not on the local subnet
- **DNS Server:** IP address of the Domain Name System (DNS) server
- **Listening Port:** port number for the embedded Web server

IP CONFIGURATION

Only users with FULL permissions shall have access to this Web page and be allowed to configure the interface. You are only required to complete the information for the parameters that you wish to change; all previously entered and saved information remains the by default.

Sorensen DLM Power Supply Interface
 DEVICE: LXI-Sorensen-DLM150-4M130

HOME IP CONFIGURATION SETTINGS STATUS SECURITY SLAVE INFO

IP CONFIGURATION: LXI

Host Name: S-DLM150-4-0934
 Description: Sorensen Power Supply DLM150-4

TCP/IP Primary Configuration:
 Use a Static IP Address
 Obtain an IP Address Automatically
 Auto IP Enabled

TCP/IP Secondary Configuration:
 Use a Static IP Address
 Obtain an IP Address Automatically
 Auto IP Enabled

IP Address: 192 . 168 . 0 . 200
 Subnet Mask: 255 . 255 . 0 . 0
 Gateway: 0 . 0 . 0 . 0
 DNS Server: 0 . 0 . 0 . 0
 Listening Port: 9221

APPLY

© 2005 Elgar Electronics Corporation

Figure 2-17. DLM IP Configuration Page

Sorensen DCS Power Supply Interface
 DEVICE: LXI-Sorensen-DCS80-15M130

HOME IP CONFIGURATION SETTINGS STATUS SECURITY SLAVE INFO

IP CONFIGURATION: LXI

Host Name: S-DCS80-15-067
 Description: Sorensen Power Supply DCS80-15

TCP/IP Primary Configuration:
 Use a Static IP Address
 Obtain an IP Address Automatically
 Auto IP Enabled

TCP/IP Secondary Configuration:
 Use a Static IP Address
 Obtain an IP Address Automatically
 Auto IP Enabled

IP Address: 192 . 168 . 0 . 204
 Subnet Mask: 255 . 255 . 0 . 0
 Gateway: 0 . 0 . 0 . 0
 DNS Server: 0 . 0 . 0 . 0
 Listening Port: 9221

APPLY

© 2005 Elgar Electronics Corporation

Figure 2-18. DCS IP Configuration Page

- **Host Name:** the default name includes the base model number of your power supply, with the last four digits of the serial number. You may change this name as long as it is unique so that VXI-11 Discovery and any other IP Discovery program can identify your specific device on your network.

To change: Type the new name (15 characters maximum) in the blank field provided and click **Apply** to update (or make all desired changes before clicking **Apply**).

- **Description:** you may change the default factory setting to something more meaningful to your current setup.

To change: Type your customized description, up to 64 characters, in the blank field provided, and click **Apply** to update (or make all desired changes before clicking **Apply**).

TCP/IP Configuration: the power supply has two TCP/IP configurations that can be set, Primary and Secondary. If the Primary Configuration is not valid on your network, the power supply will attempt to try the Secondary Configuration.

NOTE: The power supply will NOT try the Secondary Configuration if you have selected the Primary Configuration options, **Obtain an IP Address Automatically** and **Auto IP Enabled**.

You may statically assign an IP address as well as configure other Ethernet/LAN parameters, or you may keep/return to its default setting for automatic assignment of an IP address.

To assign: Click the radio button next to **Use a Static IP Address** to manually configure some or all of the following the Ethernet/LAN parameters:

IP Address – input any standard IP address. (Factory setting is 192.168.0.200). After clicking **Apply**, you also must reset the power supply and then exit and restart the Web browser to effect this change. If you have changed the network portion of the IP address, it may be necessary to alter the network settings of your attached computer to reconnect to the power supply.

Subnet Mask – input a value that identifies which network segment your power supply is on, consisting of 4 whole numbers, each ranging from 0 through 255, separated by periods. (Factory setting is 255.255.255.0, a class-C network subnet mask). Click **Apply** to update (or make all desired changes before clicking **Apply**).

Gateway – input the IP Address of any gateway that stands between the instrument and any other network entities that communicate with the power

supply. (No factory setting). Click **Apply** to update (or make all desired changes before clicking **Apply**).

DNS Server – input an IP address for the Domain Name System (DNS) server. Click **Apply** to update (or make all desired changes before clicking **Apply**). This field has no factory setting.

Listening Port – input a port number for the embedded Web server, ranging in value from 1025 – 65535. Click **Apply** to update (or make all desired changes before clicking **Apply**). The factory default port number is 9221.

To automate: (To return to the default setting): Click the radio button next to **Obtain an IP Address Automatically** for dynamic address acquisition from the DHCP server.

Auto IP Enabled: allows the power supply to assign itself an IP address in the range from 169.254.0.1 to 169.254.255.254 with a subnet mask of 255.255.0.0. If it is enabled, when there is no DHCP server available, the power supply will assign itself an IP address. However, please keep in mind that when you select **Obtain an IP Address Automatically** and you check **Auto IP Enabled** in **TCP/IP Primary Configuration**, the system will not try the Secondary Configuration.

To enable: Click in the box to check; click again to uncheck so that it is no longer enabled.

Example TCP/IP Configurations:

Primary: Use a Static IP Address

Secondary: Obtain an IP Address Automatically (DHCP)

At power-up the power supply will assign itself the configured static IP address. If no other device is using the IP address, the power supply continues with that static IP address. If some other device is using that address, the power supply will move to Secondary and attempt to acquire an IP address from a DHCP server repeatedly until it gets an address.

Primary: Use a Static IP Address

Secondary: Obtain an IP Address Automatically (DHCP) and AutoIP Enabled

At power-up the power supply will assign itself the static IP address. If no other device is using the IP address, the power supply continues with that static IP address. If some other device is using that address, the power supply will move to secondary and attempt to acquire an IP address from a DHCP server. If it cannot find a DHCP server to assign an address, it will assign itself a link-local address. If no other device is using that link-local address it will use it for 5 minutes minimum. At that time, if it is already in communication with some other device, it will hold onto that link-local address until the communication is finished and then retry DHCP. Then, if DHCP is not available, the power supply will revert to the last successful link-local address for another 5 minutes minimum.

Primary: Obtain an IP Address Automatically (DHCP) and AutoIP Enabled
Secondary: no matter the setting, will never be attempted

At power-up the power supply will attempt to acquire an IP address from a DHCP server. If it cannot find a DHCP server to assign an address, it will assign itself a link-local address. If no other device is using that link-local address, it will use it for 5 minutes minimum. At that time, if it is already in communication with some other device, it will hold onto the link-local address until the communication is finished and then retry DHCP. If DHCP is not available, the power supply will revert to the last successful link-local address for another 5 minutes minimum.

Primary: Obtain an IP Address Automatically (DHCP)
Secondary: Use a Static IP Address

At power-up the power supply will attempt to acquire an IP address from a DHCP server. If it cannot find a DHCP server to assign an address, the power supply will move to Secondary and assign itself the static IP address. If no other device is using the IP address, the power supply continues with that static IP address. If some other device is using the static IP address, the power supply will move back to Primary and start the entire operation again

SETTINGS

The Settings page is available to users who have FULL, Read/Write or Read Only access to at least one power supply (Read Only users can make no changes to the settings). If you have a system with a single master and many slaves, you could have access to one or more individual power supplies in the system (see SECURITY pages).

The screenshot shows the 'Sorensen DLM Power Supply Interface' settings page. At the top, there is a navigation bar with tabs for HOME, IP CONFIGURATION, SETTINGS (selected), STATUS, SECURITY, and SLAVE INFO. Below the navigation bar, the page title is 'SETTINGS:'. The main content area is divided into several sections. On the left, there are two large green numbers: '8.921' and '0.000'. Below these are input fields for 'Voltage' (Set V) with a value of 9.00, 'Current' (Set I) with a value of 2.00, and 'OVP' (Set OVP) with a value of 165.00. There is an 'APPLY' button next to the OVP field. To the right of these fields are radio buttons for 'CC', 'OVP', 'FAULT', 'CV', and 'OUTPUT'. The 'OUTPUT' radio button is selected. Below these are buttons for 'Power-on Default', 'RECALL SETTINGS', and 'SAVE SETTINGS'. On the far right, there is an 'Output' section with buttons for 'CLEAR OVP', 'CLEAR FAULT', 'OUTPUT', 'FRONT PANEL LOCKOUT', and 'INSTRUMENT ID'. At the bottom of the page, there is a 'SCPI Command History' section with a text area and buttons for 'SEND COMMAND', 'SEND AND READ', and 'CLEAR RESPONSES'. The footer of the page contains the copyright notice '© 2005 Elgar Electronics Corporation'.

Figure 2-19. Settings Page

- **Selected Channel:** selected power supply channel whose Settings are presently displayed/updated (1= Master channel, and 2 – 31 = slave channels); you can select a different channel to which you have access:

To select: Click and hold the drop-down button; you will see only the channel numbers that you have rights to access; click the desired channel number.
NOTE: If no channels are displayed, an Administrator or a user with FULL permission (see **SECURITY**, p. 2-24) must assign channel access to the particular User ID, through the Security page (Figure 2-22), using the **ALLOCATE CHANNELS** capability.

Below Selected Channel you will see continuous updates (2-5 times per second) of the actual voltage output (value displayed on the left) and the actual live current output (value displayed to the right).

- **Voltage:** value above is updated with actual voltage output of the power supply
- **Current:** value above is updated with actual live current output
- **Set V:** the programmed voltage setting
- **Set I:** the programmed current setting
- **Set OVP:** the programmed over voltage protection setting
- **APPLY:** puts into effect the newly input settings
- **CC and CV indicators:** presently operating output mode of the power supply, either constant voltage or constant current.
- **OVP indicator:** highlighted red if over voltage protection is activated
- **FAULT indicator:** highlighted red if fault has occurred
- **OUTPUT indicator:** solid-lit shows power output status is On

If you have Read/Write access, you can change the following settings (after inputting desired settings, click **APPLY**):

- **Set V** – click in the Set V field and input a new value for voltage.
- **Set I:** click in the Set I field and input a new value for current.
- **Set OVP:** click in the Set OVP field and input a new value for over voltage protection.

Output – click the applicable button(s) as follows:

- **CLEAR OVP:** to clear the OVP indication/condition after clearing the cause of the event. The power supply will revert to the last saved values for Voltage, Current, and OVP. Be sure to reset these values, if desired, before clearing an OVP condition.
- **CLEAR FAULT:** to clear the hardware fault indication/condition after clearing the cause of the event.

- **OUTPUT:** to turn on or off the power output (see Output indicator)
- **FRONT PANEL LOCKOUT:** to prevent or enable changes being made via the front panel (LED to the left is lit when Lockout is in effect).
- **INSTRUMENT ID:** click to identify which power supply (instrument) in a rack of equipment corresponds to the Channel selected. The LED to the left of this button indicates whether or not this function is turned on (ON causes the instrument's rear panel NET LED to flash; the flashing continues until you click **INSTRUMENT ID** again).

Power-on Default: click the applicable button(s) as follows:

- **RECALL SETTINGS:** click to restore the programmed Power-on defaults into the Set V, Set I and Set OVP settings, and to the power supply output (these defaults are those that were last saved prior to this Power-on).
- **SAVE SETTINGS:** after clicking **APPLY**, click to save the presently set values displayed in the Set V, Set I and Set OVP fields into non-volatile flash. (If only one new setting had been input, the other previously saved values remain the same). **Please be aware that these then become the new power-on settings that will be applied at power-up time and after OVP reset as described in "Clear OVP" above.**

NOTE: When you click **SAVE SETTINGS**, you will get a pop-up alert (Figure 2-20) telling you that saving a non-zero voltage may cause the power supply to power-on with a voltage on its output terminals after a restart or power cycle.



Figure 2-20. Alert Message for Save Settings

SCPI command section:

- **SEND COMMAND:** (not to be used with any command that provides a response) input a properly formatted SCPI command in the upper of the two windows and click this button to send the command.
- **SEND AND READ:** for queries, input a properly formatted SCPI query command in the upper of the two windows, and click this button to send the command and read the response in the lower of the two windows.
- **SCPI Command History:** a history of the last few commands sent to the power supply are remembered by the system and listed in this area. You can click on a command to have it be pasted in the command window.
- **CLEAR RESPONSES:** click this button to clear the response window of previous responses.

STATUS

This page displays updated information for the following parameters:

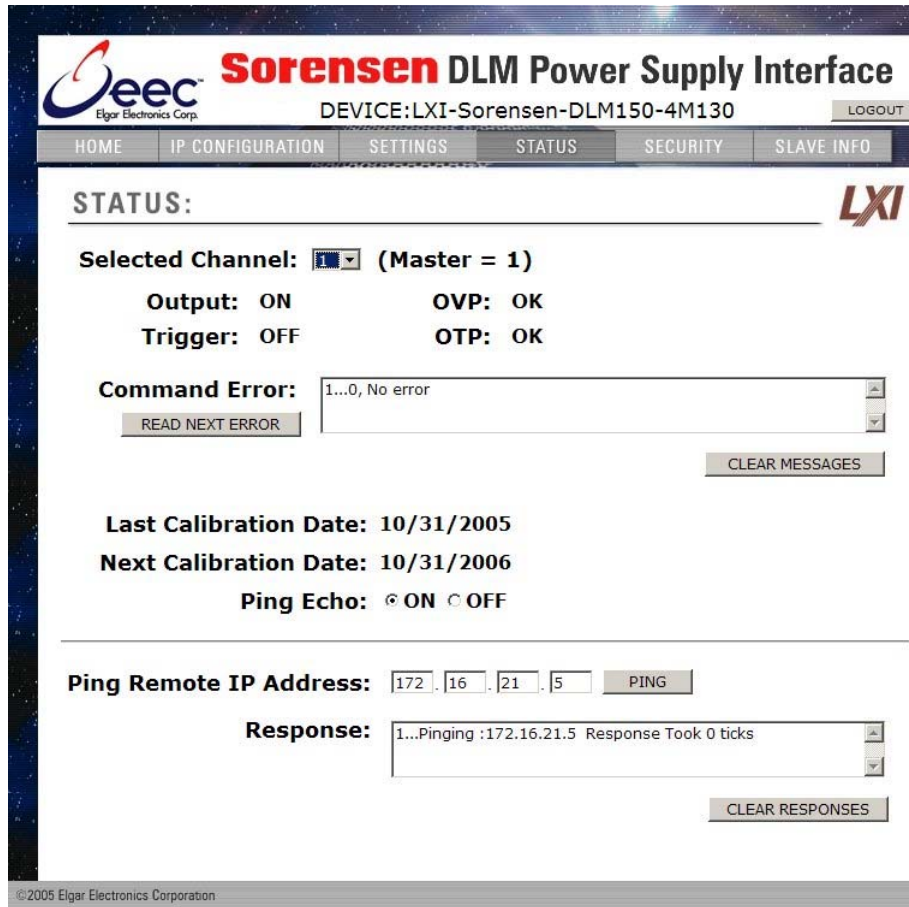

Figure 2-21. Status Page

- Selected Channel:** as in the Settings page, this is the selected power supply channel whose information is presently displayed/updated (1= Master channel, and 2 – 31 = Slave channels); you can select a different channel to which you have access:

To select: Click and hold the drop-down button; you will see only the channel numbers that you have rights to access; highlight the desired channel number and release the mouse button.

NOTE: If no channels are displayed, an Administrator or a user with FULL permission (see **SECURITY**, p. 2-24) must assign channel access to the particular User ID, through the Security page (Figure 2-22), using the **ALLOCATE CHANNELS** capability.

- Output:** displays the power output status, ON or OFF

- **Trigger:** set up by SCPI commands, displays whether the Trigger state is OFF, ARMED, or TRIGGERED.
- **OVP:** displays Read Only status of over voltage protection, either OK (normal) or TRIPPED.
- **OTP:** displays Read Only status of over temperature condition, either OK (normal) or TRIPPED.
- **Command Error:** displays command and syntax errors that are queued in the supply.
- **Read Next Error:** each click brings the next error into the Command Error display, until no other errors are in the queue.
- **CLEAR MESSAGES:** click this button to clear the Command Error message window of past messages.
- **Last Calibration Date:** displays the date that the power supply (instrument) was last calibrated; configurable with SCPI commands, normally at the time of calibration.
- **Next Calibration Date:** displays the date that the power supply should be calibrated next; also configurable with SCPI commands, normally calculated at time of calibration.
- **Ping Echo:** except for Read Only users, allows turning echo ability On or Off, depending on whether or not you want the supply to respond to a Ping command from another device on the network. The default setting for Ping Echo is response enabled. Click the OFF radio button if you do not want the supply to respond to a ping.
- **Ping Remote IP Address:** allows you to input an IP address of another device in the system
- **Ping:** click this button to ping the device at the address that you entered in the **Ping Remote IP Address** field.
- **Response:** displays the result of your ping. For Example, if the Ping Address were 69.36.230.190, the Response window would display:
 Pinging :69.36.230.190 Response Took 0 ticks

 Or

 Ping Failed (if the host specified is not in the network)
- **CLEAR RESPONSES:** click this button to clear the Response window of past ping responses.

SECURITY

Accessible only if you have Administrative (Full) rights, this page allows you to set up new user accounts for access to the power supply(s). It displays all of the currently set up users and respective permission levels.

- FULL = full rights/Administrator
- RW = read and write to power supply(s)
- R = Read Only
- -L = identifies user currently logged onto a power supply session.

The screenshot shows the 'SECURITY' page of the Sorensen DLM Power Supply Interface. The page header includes the 'epec' logo, the title 'Sorensen DLM Power Supply Interface', and the device ID 'LXI-Sorensen-DLM150-4M130'. A navigation bar contains links for HOME, IP CONFIGURATION, SETTINGS, STATUS, SECURITY (selected), and SLAVE INFO. The main content area is titled 'SECURITY:' and features a table of users and their permissions. Below the table are buttons for 'ADD', 'REMOVE', 'EDIT', and 'ALLOCATE CHANNELS'. The footer contains the copyright notice '©2005 Elgar Electronics Corporation'.

User Name	Permission
admin	FULL-L
user3	R
user4	RW
user5	RW
user6	RW
user7	RW
user8	R
user9	R
readonly	R

Figure 2-22. Security Page

- **ADD:** Click to pull up a separate page in which to input new users with passwords and permission levels. (See Figure 2-23).
- **REMOVE:** Click to delete selected user after first highlighting their User Name row. The Admin user cannot be removed.
- **EDIT:** Click to change settings (name/permissions) for selected user after first highlighting their User Name row. This brings up the Edit Existing User window (Figure 2-24).
- **Allocate Channels:** click to pull up the Channel Allocation page, which presents a matrix of all users and all possible power supply channels, whether they are in the system or not. (See Figure 2-25).

ADD NEW USER

Accessible from the Security Page by clicking the ADD button, this page is allows you (a Full permissions user) to add new users with their passwords and permission levels.

The screenshot shows the 'ADD NEW USER' window in the Sorensen DLM Power Supply Interface. The window has a header with the 'Deec' logo (Elgar Electronics Corp.) and the title 'Sorensen DLM Power Supply Interface'. Below the title, the device ID 'LXI-Sorensen-DLM150-4M130' and a 'LOGOUT' button are visible. The main content area is titled 'ADD NEW USER:' and contains the following form elements:

- User ID:** A text input field.
- Password:** A text input field.
- Re-enter Password:** A text input field.
- Permission:** A dropdown menu currently showing 'R'.
- Buttons:** 'SUBMIT', 'CANCEL', and 'RESET' buttons.

The footer of the window displays '©2005 Elgar Electronics Corporation'.

Figure 2-23. Add New User Window from Security Page

- To add:
1. Input appropriate information in **User ID** (case-sensitive, limited to 14 characters), in **Password** (case sensitive, limited to 9 characters), and in **Re-enter Password** fields.
 2. Select permission level from the **Permission** dropdown.
 3. To accept into the system, click **SUBMIT** or tap the ENTER key.

In the ADD NEW USER: line, you will see a message that the [new user name] was added successfully, or a message that it was unsuccessful and the reason.

NOTE: In order to complete the addition of a new user, you must also allocate channels to that user. (See CHANNEL ALLOCATION, p. 2-27).

RESET clears the fields in which you input information.

CANCEL returns you to the Security page. This button does NOT “undo” previous successful submit operations.

EDIT EXISTING USER

Accessible from the Security Page by clicking the EDIT button after first selecting the user's name, this page allows you (a Full permissions user) to edit the parameters for an existing user.

Figure 2-24. Edit Existing User Window from Security Page

When this page appears, the fields are populated with the selected user's existing parameters.

- To edit:
1. Input appropriate information, as desired, in **User ID** (case-sensitive, limited to 14 characters), in **Password** (case sensitive, limited to 9 characters), and/or in **Re-enter Password** fields.
 2. Select permission level from the **Permission** dropdown.
 3. To accept into the system, click **SUBMIT** or tap the ENTER key.

If your edit was successful, you will return to the Security page with a message to that effect.

If there is an error in the editing process, you will stay in the Edit Existing User page, and you will see a message in the EDIT EXISTING USER: line, describing the reason for the error.

RESET clears the fields in which you input information.

CANCEL returns you to the Security page with a message verifying that the User Edit was cancelled.

CHANNEL ALLOCATION

Accessible from the Security Page by clicking the ALLOCATE CHANNELS button, this page allows you (a Full permissions user) to select a user and select the power supply(s) to which that user shall have access.

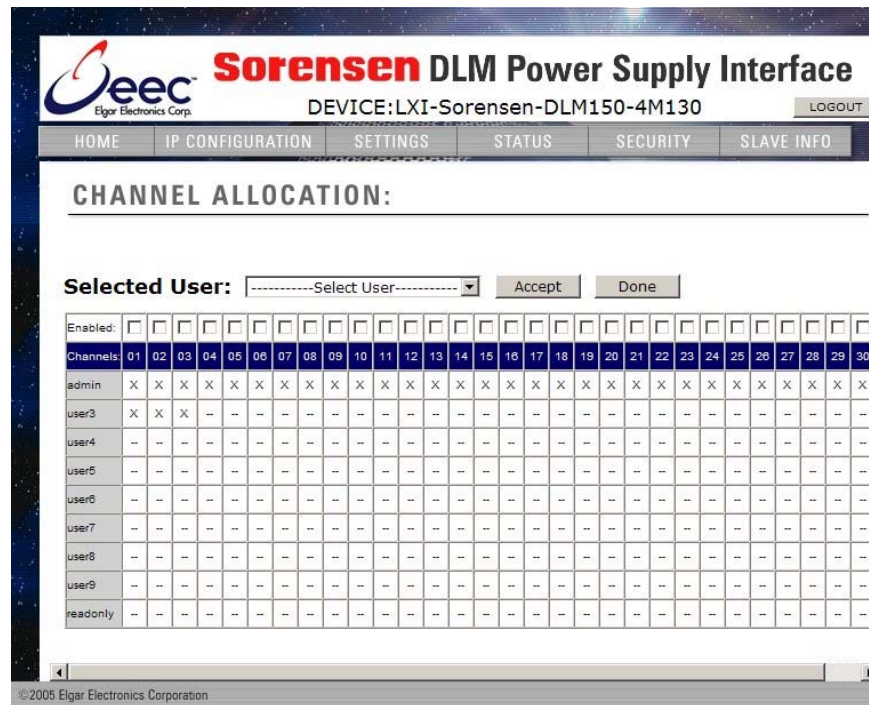

Figure 2-25. Channel Allocation Window from Security Page

X indicates which power supply (channel) each user has access to.

Because an Administrator has full rights to all functions of the power supply(s), a user with FULL permissions has access to all channels regardless of whether the Channel Allocation page indicates he has permissions or not.

- To change:
1. Select a user from the **Selected User** drop-down, and check or uncheck the boxes above the desired channel numbers.
 2. Click **Accept**. Repeat for each user for whom you are changing/allocating channels.
 3. When finished, click **Done** to return to the initial Security page.

SLAVE INFO

This page displays information only for the power supplies configured in this system (one master power supply with a single IP address and up to 30 slave power supplies – M131 and/or M85). The information for each power supply displayed includes the Channel number (1 is the Master; 2 through 31 are Slaves), the model number, the serial number, and the firmware revision.

Sorensen DLM Power Supply Interface
 DEVICE: LXI-Sorensen-DLM150-4M130

SLAVE INFORMATION:

CH	Model	Serial No.	F/W Rev.
1	DLM150-4M130	0541A00934	2.00
2			
3			
4			
5			
6			
7			
8			
9			
10			
11			
12			
13			
14			
15			
16			
17			
18			
19			
20			
21			
22			
23			
24			
25			
26			
27			
28			
29			
30			
31			

© 2005 Elgar Electronics Corporation

Figure 2-26. Slave Information Page

Upon first entering this page, you will see information only for the slaves with which the master established communication during the present session. Click **REFRESH SLAVE DATA** to see the information on the remaining slaves present in this system. (This refresh operation could take up to 60 seconds).

2.4.5 TROUBLESHOOTING

Resetting IP Configuration

Either press and hold in the IP reset switch (S2) on the rear panel until the green NET LED flashes (this could take 5 or more seconds), which resets the Primary configuration to DHCP *and* AutoIP Enabled (and ignores Secondary configuration), or send the SCPI command, SYST:NET:IP xxx.xxx.xxx.xxx through one of the following: the RS-232, the Server, or VXI-11. This sets the primary configuration to Static IP, and the secondary configuration is left where it presently is.

Cannot Establish Communication

Use RS232 port. Note 19.2k baud rate at J6.

Query IP address with the SCPI command, SYST:NET:IP?

Query the MAC address with the SCPI command, SYST:NET:MAC?

For Slave (M131) communication issues, check the slave unit address switch setting.

Communication Established, but No Power Supply Response

Check SCPI string for errors (use the command SYST:ERR? to check response from unit)

Web Page Does Not Come Up

Check IP address; validate your SUBNET Mask.

Verify that both your computer and the power supply are on the same network.

If using a direct connection with a crossover cable, verify the PC is set to static IP address on the same network.

Observe the indicator LED on Ethernet port (J11) for activity. The NET LED (at rear panel center, near IP reset switch) will be lit when communication is established.

Lost/Forgot Password

If you are a user, contact the Administrator of the power supply network to modify your password.

If you are the administrator, the only way to recover is to press and hold the IP reset switch on the rear panel until the Green NET LED blinks (this could take five or more seconds). The administrator User Name and password will be restored to factory defaults, as will the IP Address, the IP Addressing Mode, Ping Enable, SUBNET Mask, Host name, and Description String. All other defined user names and passwords are not affected by the reset operation.

2.5 REMOTE PROGRAMMING VIA RS-232

The M130's RS-232 interface operates at 19.2K baud with 8 data bits, no parity, and 1 stop bit. All M130 commands are supported at the RS-232 interface. The RS-232 interface is accessible through the power supply's rear panel 6-pin RJ-11 connector, labeled RS232(485).

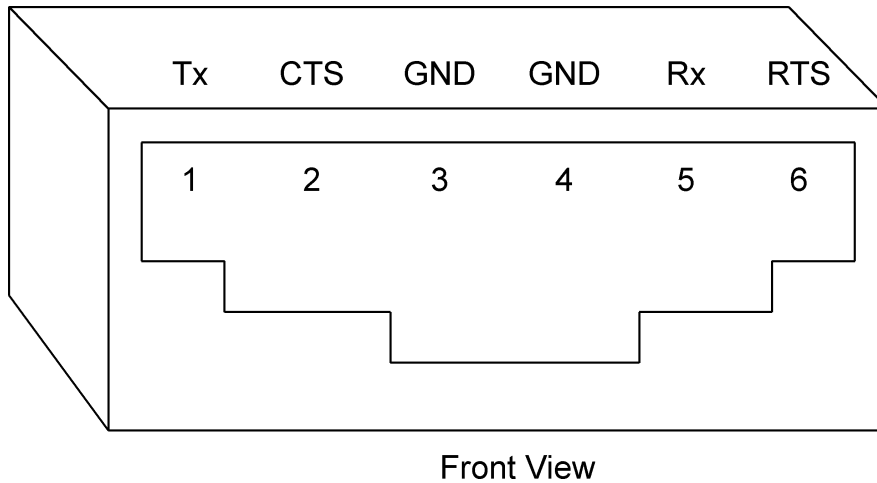

Figure 2-27. RS-232 Rear Panel RJ-11 Connector Pinout

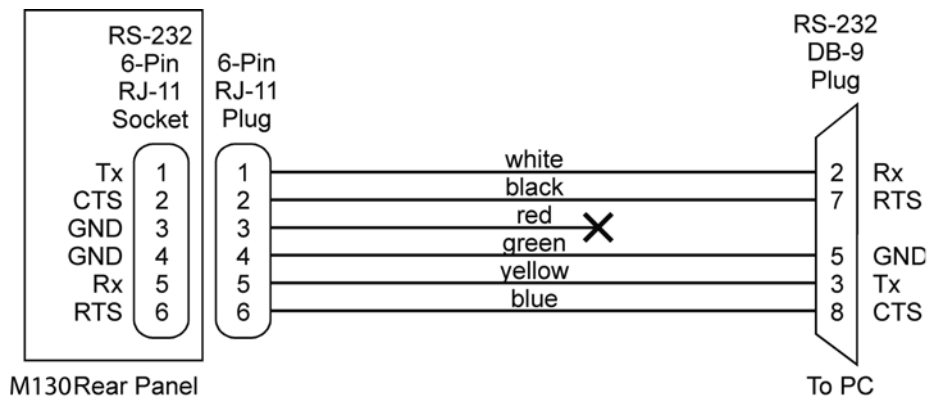

Figure 2-28. M130 to PC RS-232 Connection (RJ-11 to DB-9)

2.6 EXTENDED INTERFACE BUS (EIB) WITH THE M131 OPTION

The M130 Master unit communicates with up to thirty M131 Slave units via a RS-485 serial interface port on rear panel. To connect a M130 Master to a M131 Slave, insert a 6-conductor serial cable (with male RJ11 connectors at both ends) between the RS-485 ports on the Master and Slave units. Additional Slave units can be "daisy chained" together via their respective RS-485 ports. Please refer to the applicable power supply manual (DCS or DLM600) for more detail.

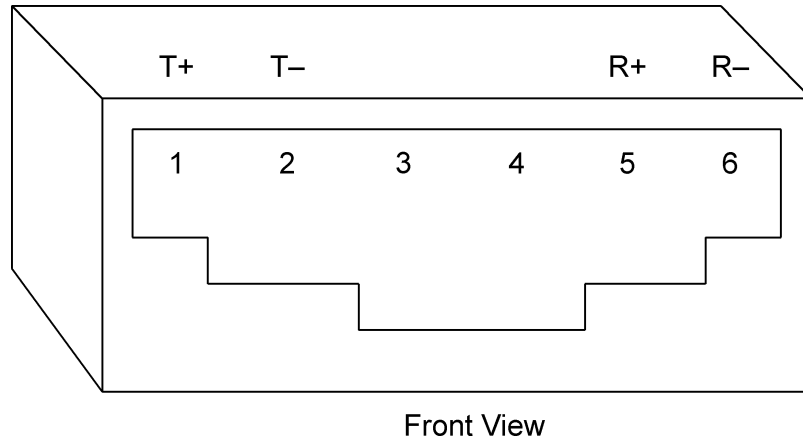

Figure 2-29. EIB (RS485) Rear Panel RJ-11 Connector Pinout

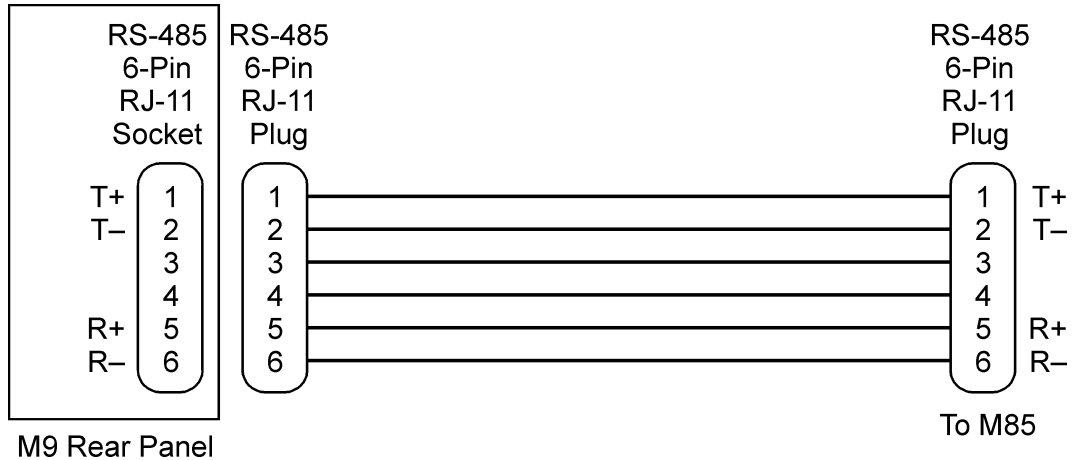

Figure 2-30. M130 to M131 EIB Connection (RJ-11 to RJ-11)

This page intentionally left blank.

SECTION 3

IEEE 488.2 AND SCPI

COMMAND OPERATION

3.1 INTRODUCTION

The following sections describe the operation of the M130 by remote programming using the M130 IEEE-488.2 and SCPI command sets. The supply IEEE488.2 and SCPI command sets provide programming, query, and status commands that facilitate remote control of the power supply.

3.2 IEEE-488.2 REGISTER DEFINITIONS

The M130 supports the IEEE-488.2 and SCPI 1995.0 status reporting data structures. These structures are comprised of status registers and status register enable mask pairs. The following sections describe these pairs.

3.2.1 SCPI STATUS BYTE

- To read the SCPI Status Byte status register, either send the *STB? command or issue a GPIB or Ethernet serial poll. To clear the Status Byte status register, send the *CLS command.
- To configure the supply to request service from the Ethernet controller, set the appropriate bits in the Service Request Enable (SRE) register. The SRE register has the same bit pattern as the SCPI Status Byte.
- To modify the SRE register, use the *SRE <mask> command; to read it, use the *SRE? command. For example, if the SRE register is set to 0x10 (MAV), then when the supply has a message available, the Status Byte register will contain 0x50 (RQS and MAV). See Table 3-1.

Table 3-1 SCPI Status Byte

Bit	Hex Value	Description
0	0x01	Not used.
1	0x02	Protection Event Status flag. Indicates the selected protection event occurred.
2	0x04	Error/event queue message available. Set when any error/event is entered in the System Error Queue. It is read using the SYSTem:ERRor? query.
3	0x08	Questionable Status flag. Indicates the quality of the current data being acquired. This bit is not used.
4	0x10	Message available (MAV). Indicates a message is available in the GPIB or Ethernet output queue. Cleared after the GPIB or Ethernet output buffer is read.
5	0x20	Standard Event Status Register (ESR). Summary bit for the ESR. Set when any of the ESR bits are set and cleared when the ESR is read.
6	0x40	Request Service flag (RQS) for serial polling or Master Summary Status (MSS) in response to *STB? If service requests are enabled (with the *SRE command), this bit represents the RQS and will be sent in response to a serial poll, then cleared. If RQS is not enabled, the bit represents the MSS bit and indicates the device has at least one reason to request service. Even though the device sends the MSS bit in response to a status query (*STB?), it is not sent in response to a serial poll. It is not considered part of the IEEE-488.1 Status Byte.
7	0x80	Operation Status flag. Indicates the current operational state of the unit. This bit is not used.

3.2.2 STANDARD EVENT STATUS REGISTER (ESR)

- To read the Standard Event Status Register (ESR), use the *ESR? command.
- To clear the ESR, either read this register or issue the *CLS command.
- To enable corresponding ESR bits to be summarized in the summary bit of the SCPI Status byte, issue the *ESE (Standard Event Status Enable Register) command.

Table 3-2 Standard Event Status Register

Bit	Hex Value	Description
0	0x01	Operation Complete
1	0x02	Request Control - not used
2	0x04	Query Error
3	0x08	Device Dependent Error
4	0x10	Execution Error (e.g., range error)
5	0x20	Command Error (e.g., syntax error)
6	0x40	User Request - not used
7	0x80	Power On

3.2.3 PROTECTION CONDITION AND PROTECTION EVENT STATUS REGISTERS

These two registers have the same bit meanings, but they differ in function.

- To read the **Protection Condition**, use the STAT:PROT:COND? command. This command gives the *present status condition* of the power hardware, so the data is not latched. It is a polling register.
- To read the **Protection Event Status**, use the STATus:PROTEction:EVENT? command. To clear the Protection Event Status Register, either read this register with the *RST command, or issue the *CLS command.
- To set bits in the Protection Event Status Register, you must first set the corresponding bit in the Protection Event Status Enable Register and the corresponding event must occur.
- To set the Enable Register, issue the STATus:PROTEction:ENABLE <mask> command. The status is then latched and will remain in that state until it is read or cleared due to some command action. Then use the STATus:PROTEction:ENABLE? query to read the Enable Register.

Table 3-3 Protection Condition and Event Status Registers

Bit	Hex Value	Description
0	0x01	Constant voltage operation
1	0x02	Constant current operation
2	0x04	Not used
3	0x08	Overvoltage protection tripped
4	0x10	Overtemperature protection tripped
5	0x20	Supply external shutdown active
6	0x40	Foldback mode operation
7	0x80	Remote programming error

3.2.4 OPERATION STATUS AND QUESTIONABLE STATUS REGISTERS

The Operation Status and Questionable Status Registers will always return 0 when queried. The Operation Status Enable and Questionable Status Enable Registers can be programmed and queried to allow SCPI compatibility but have no effect on the Operation Status and Questionable Status Registers.

3.2.5 ERROR/EVENT QUEUE

The supply maintains an Error/Event Queue as defined by SCPI. The queue holds up to 10 error events.

To view the error events, use the `SYSTEM:ERRor?` Query command, which reads in a First In/First Out (FIFO) manner. The read operation removes the entry from the queue. The `*CLS` command clears all entries from the queue.

The following error codes are defined in the SCPI 1995.0 specification and are supported by the M130. Error codes are in the range of [-32768, 32767]. SCPI reserves the negative error codes and 0, while error codes greater than 0 are device-specific errors.

Table 3-4 SCPI Error Codes

Error Code	Description
208	Isolation relay must open first An attempt to change the state of the polarity relay was made while the isolation relay was closed. First open the isolation relay; then change the state of the polarity relay.
207	Voltage sign mismatched polarity relay state The algebraic sign on the voltage of a voltage programming command, such as <code>SOUR:VOLT <volt></code> , did not match the state of the polarity relay, so the voltage command was ignored. For example, if the polarity relay is in the positive voltage position (normal output voltage position), the command <code>SOUR:VOLT -5</code> will cause this error. Conversely, if the polarity relay is in the negative voltage position (inverted output voltage position), the command <code>SOUR:VOLT 5</code> will cause this error. Note that programming Over Voltage Protection with a mismatched algebraic sign also can cause this error.
206	No channels setup to trigger An attempt was made to trigger the M130 using the <code>TRIG:TYPE <1 2 3></code> command when there are no armed trigger settings. This error is <i>not</i> generated when the GET is received, even when there are no armed trigger settings.
205	GPIB or Ethernet GET not allowed during message The GPIB or Ethernet G(roup) E(xecute) T(rigger) multiline command was errantly generated by the system computer while or very shortly after a message is or was sent. Give a few milliseconds after a message is sent before attempting a GET; and never send a GET during a message transfer over the GPIB or Ethernet.

Error Code	Description
204	GPIO or Ethernet IFC caused warm boot This error relates to the GPIO or Ethernet IFC signal, and is available only in association with a proprietary command.
203	Hardware watchdog warm boot Caused by a hardware fault either in the power supply proper, or on the M130. One possible explanation might be that the mains power to the supply was interrupted for a short but sufficient time to cause the M130 processor to reset and re-boot. Also, it might be possible to generate this error by a very momentary power-off through the front panel power switch.
202	Foreground watchdog warm boot The internal firmware on the M130 found an internal error condition that halted processing; to force resumption of processing, a warm boot is required.
201	Unexpected warm boot The M130 GPIO or Ethernet-side processor experienced a warm boot that was unexpected, and it may indicate an internal crash of the M130 processor.
102	Incompatible unit type This error is not used. It cannot occur.
101	Incompatible unit version This slave does not support user defined initialization values nor ramping; its firmware is too old a version to do so. Slave #n provides its firmware version number as the last number on the response from the *IDN[n]? query command.
100	Incompatibility error This error is not used. It cannot occur.
0	No error The error queue is empty.
-102	Syntax error An unrecognized command or data type was encountered.
-108	Parameter not allowed More arguments than expected were received.
-151	Invalid string data Incorrect password. Manufacturer, model, or serial number string was more than 16 characters. Invalid mnemonic.
-161	Invalid block data The expected number of data values was not received.
-200	Execution error An error/event number in the range [-299,-200] indicates that an error has been detected by the instruments execution control block. The occurrence of any error in this class shall cause the execution error bit (bit 4) in the Event Status Register to be set. An execution error can be the result of: <ul style="list-style-type: none"> • A <program data> element out of range, such as programming 35 volts in a 33 volt device. • A command could not be executed due to the current condition of the device.
-203	Command protected Attempted to store calibration values to EEPROM without unlocking.

Error Code	Description
-221	Settings conflict Attempted to set output greater than soft limits or to set soft limits less than output.
-222	Data out of range Parameter exceeded range of valid values.
-225	Out of memory There is not enough memory to perform the requested operation.
-241	Hardware missing A legal command or query could not be executed because the option is not installed.
-284	Program currently running A legal command or query could not be executed because a function is currently running.
-292	Referenced name does not exist
-293	Referenced name already exists
-316	Checksum error
-330	Self-test failed A self-test failure has occurred.
-340	Calibration failed Error during calculation of calibration values occurred.
-350	Queue overflow The error queue can contain up to 10 entries. If more than 10 error/event conditions are logged before the SYSTem:ERRor? query, an overflow will occur; the last queue entry will be overwritten with error -350. When the queue overflows, the least recent error/events remain in the queue and the most recent error/events are discarded.
-360	Communication error Communication to a channel was disrupted.

3.2.6 SERIAL POLL OPERATION

Performing a serial poll will not modify the Status Byte other than to clear the RQS (bit 6) for a supply requesting service. Queries affecting the Status Registers and subsequent serial poll are described below:

- *STB? clears the Status Byte
- *ESR? clears the ESR and bit 5 of the Status Register
- SYSTem:ERRor? clears bit 2 of the Status Register if the queue is empty

3.3 IEEE-488.2 AND SCPI CONFORMANCE INFORMATION

The supply conforms to most of the specifications for devices as defined in IEEE-488.2 and SCPI Version 1995.0. Confirmed Commands are those that are approved commands in the SCPI 1995 Specification, Volume 2: Command Reference. Confirmed Commands are denoted by a “C” in the “SCPI” column. Any commands that are not Confirmed Commands are labeled as Not Approved denoted by an “N” (e.g., Section 3.5.2).

3.3.1 PARAMETER DEFINITIONS

Table 3-5 Parameter Definitions

PARAMETER DEFINITIONS	
Type	Valid Arguments
<boolean>	“ON” or 1. “OFF” or 0.
<NR1>	The data format <NR1> is defined in IEEE-488.2 for integers. Zero, positive and negative integer numeric values are valid data.
<0+NR1>	Zero and positive integer numeric values.
<-NR1>	Negative integer numeric values.
<NRf>	The data format <NRf> is defined in IEEE-488.2 for flexible Numeric Representation. Zero, positive and negative floating point numeric values are some examples of valid data.
<0+NRf>	Zero and positive floating point numeric values.
<-NRf>	Negative floating point numeric values.
<string>	Characters enclosed by single or double quotes.

3.3.2 UNITS

The Series M130 will accept the following units as suffixes to numeric values:

Table 3-6 M130 Units

UNITS	
Type of Unit	Valid Suffix
Voltage	“VOLTS” or “volts”, “V” or “v”, “MV” or “mv” or “mV”
Current	“AMPS” or “amps”, “A” or “a”, “MA” or “ma” or “mA”
Time	“SEC” or “sec”, “S” or “s”, “MS” or “ms”, “MIN” or “min”
Frequency	“HZ” or “hz”

The default units are VOLTS, AMPS, SEC, and HZ. For example, “SOUR:VOLT 1” programs 1 volt. To program in units of millivolts, type “SOUR:VOLT 1mV”.

3.3.3 CONVENTIONS

SCPI uses the conventions where optional commands and parameters are enclosed by “[]”. Additionally the shorthand version of a command is indicated by capital letters. The optional parameter “[n]” selects the auxiliary channel number (power supply) being commanded. If “[n]” is not specified, the default master channel 1 is automatically selected. Channel 1 selects the master unit and channels 2-31 select an auxiliary unit attached with the M131 option. Selecting the global channel 0 is allowed only for the TRIGgerred[n] commands.

For example,

```
SOURce[n]:VOLTage[:LEVel][:IMMediate][:AMPLitude] 120.0
```

can be written as

```
SOURce[n]:VOLTage 120.0 // for any channel
```

or

```
SOUR:VOLT 120.0 // for default master channel 1
```

3.3.4 QUERIES

The query syntax is identical to the command syntax with a “?” appended and no additional parameters/arguments following. For example, to query the programmed voltage, send the string: SOURce:VOLTage?. A subsequent device read will return a value such as “33.000”. For Ethernet, all queries are terminated with a carriage return. For GPIB controllers that require termination characters, all queries are terminated with a carriage return and line feed (0x0D 0x0A). When the supply has nothing to report, its output buffer will contain two ASCII characters: a carriage return and linefeed (in decimal the values are: <13><10>).

3.4 IEEE-488.2 COMMON COMMAND SUBSYSTEM

The following commands are common to all SCPI instruments and declared mandatory by IEEE-488.2. In the following table, the M130 is defined as the “device” on the GPIB or Ethernet bus.

Command	Description
*CLS[n]	Clears all status reporting data structures including the Status Byte, Standard Event Status Register, and Error Queue. The STAT:PROT:ENAB (protection event enable register) is cleared by this command; other enable registers are not cleared by this command.
*ESE[n] <0+NR1>	Sets the value of the Standard Event Status Enable Register that determines which bits can be set in the Standard Event Status Register. See section 3.2.2 for valid values.
*ESE[n]?	Returns the integer value of the Standard Event Status Enable Register. See section 3.2.2 for valid values. Response: <0+NR1>
*ESR[n]?	Returns the integer value of the Standard Event Status Register. The ESR and the Status Byte ESR bit are cleared. See section 3.2.2 for valid values. Response: <0+NR1>
*IDN[n]?	Returns the device identification as an ASCII string. Response: <Manufacturer>, <model>, <serial number>, <DCI firmware version> <AI firmware version> Example: Sorensen, DCS33-33, B90000-0, 1.00,1.00
*OPC[n]	Enables the Operation Complete bit of the Standard Event Status Register to be set when all pending operations are complete. See section 3.2.2.
*OPC[n]?	Returns the integer value “1” when all pending operations are complete. See section 3.2.2. Response: <0+NR1>
*RST[n]	Resets the supply to its Power ON (PON) state. Clears all status reporting data structures including the Status Byte, Standard Event Status Register, and Error Queue. The STAT:PROT:ENAB (protection event enable register) is cleared by this command; other enable registers are not cleared by this command.
*SRE[n] <0+NR1>	Sets the value of the Service Request Enable Register, which determines which bits in the Status Byte will cause a service request from the device. See section on Status Byte for valid values.
*SRE[n]?	Returns the integer value of the Service Request Enable Register. See section on Status Byte for valid values. Values range from 0-63 or 128-191. Response: <0+NR1>

Command	Description
*STB[n]?	<p>Returns the integer value of the Status Byte with bit 6 representing the Master Summary Status (MSS) instead of RQS. The MSS bit acts as a summary bit for the Status Byte and indicates whether the device has at least one reason to request service based on the MAV and the ESR bits. The Status Byte is cleared. See section on Status Byte for valid values. Values range from 0-255.</p> <p>Response: <0+NR1></p>
*TST[n]?	<p>Sets the device to execute an internal self-test and return the integer value of the results. Value of "0" indicates no errors.</p> <p>Response: <0+NR1></p>
*WAI[n]	<p>Sets the device to wait until all previous commands and queries are complete before executing commands following the *WAI command.</p>

3.5 CALIBRATION SCPI COMMAND SUBSYSTEM

See Section 4 for calibration procedures.

 WARNING	<p>Please refer to the power supply manual for further information before performing calibration procedures. Calibration must be performed by qualified personnel who appropriately deal with attendant hazards. If calibration is not performed properly, functional problems could arise, requiring that the supply be returned to the factory.</p>
---	---

3.5.1 CALIBRATION SCPI COMMAND SUMMARY

CALibrate[n]

:DATA <NRf><NRf><NRf><NRf><NRf><NRf><NRf><NRf><NRf><NRf>

:INITial

:CURRent <0+NRf>

:VOLTage

[:AMPLitude] <NRf>

:PROTection <NRf>

:LOCK

:MEASure

:CURRent

:ADC?

:CALCulate

:GAIN <NRf>

:OFFSet <NRf>

:POINt <1|2> <0+NRf>

:VOLTage

:ADC?

:CALCulate

:GAIN <NRf>

:OFFSet <NRf>

:POINt <1|2> <NRf>

:MODEl

:LASTCALDATE <NRf> <NRf> <NRf>

:LASTCALDATE?

:NEXTCALDATE <NRf> <NRf> <NRf>

:NEXTCALDATE?

:OUTPut

:CURRent

:DAC <0+NR1>

:FIVEPOINT <1|2|3|4|5> <0+NRf>

:FIVEPOINT?

:GAIN <NRf>

:OFFSet <NRf>

:VOLTage

:DAC <0+NR1>
 :FIVEPOINT <1|2|3|4|5> <0+NRf>
 :FIVEPOINT?
 :GAIN <NRf>
 :OFFSet <NRf>

:PROTection
 :CALCulate
 :DAC <0+NR1>
 :GAIN <NRf>
 :OFFSet <NRf>

:STORe
 :UNLock <string>

3.5.2 CALIBRATION SCPI COMMAND REFERENCE

Command	Description	SCPI
CALibrate[n]	Calibration subsystem. n = 1-31. The default channel is 1.	C
:DATA <NRf><NRf><NRf> <NRf><NRf><NRf> <NRf><NRf><NRf> <NRf>	Sets the values of the ten floating point calibration constants: 1) output voltage DAC gain 2) output voltage DAC offset 3) output current DAC gain 4) output current DAC offset 5) output voltage protection DAC gain 6) output voltage protection DAC offset 7) voltage measurement ADC gain 8) voltage measurement ADC offset 9) current measurement ADC gain 10) current measurement ADC offset Values are separated by space or comma.	N
:INITial		N
:CURRent	Sets the power-on default value of current.	N
:VOLTage		N
[:AMPLitude] <NRf>	Sets the power-on default voltage.	N
:PROTection <NRf>	Sets the power-on default value of the overvoltage protection.	N
:LOCK	Disables access to the non-volatile memory. Prevents attempts to store calibration values.	N
:MEASure		N
:CURRent		
:ADC?	Returns the integer value of the A/D for the current measurement.	N
:CALCulate	Calculates the value of the gain and offset for current measurements.	N

Command	Description	SCPI
:GAIN <NRf>	Sets the value of the gain for current measurements.	N
:OFFSet <NRf>	Sets the value of the offset for current measurements.	N
:POINT <1 2> <0+NRf>	Sets the current measurement calibration point (1 or 2). The actual output current is measured with an external meter.	N
:VOLTage		N
:ADC?	Returns the integer value of the A/D for the voltage measurement.	N
:CALCulate	Calculates the value of the gain and offset for voltage measurements.	N
:GAIN <NRf>	Sets the value of the gain for voltage measurements.	N
:OFFSet <NRf>	Sets the value of the offset for voltage measurements.	N
:POINT <1 2> <NRf>	Sets the voltage measurement calibration point (1 or 2). The actual output voltage is measured with an external meter.	N
:MODEL		
:LASTCALDATE <NRf> <NRf> <NRf>	Sets the date last calibrated. Order: Month Day Year.	
:LASTCALDATE?	Returns the date last calibrated.	
:NEXTCALDATE <NRf> <NRf> <NRf>	Sets the due date for next calibration. Order: Month Day Year	
:NEXTCALDATE?	Returns the due date for next calibration.	
:OUTPut		N
:CURRent		N
:DAC <0+NR1>	Sets the output of the output current D/A converter. The value range is 0 – 4095 for 12-bit operations; 0-65535 for 16-bit.	N
:FIVEPOINT <1 2 3 4 5> <0+NRf>	Sets the five current calibration values.	N
:FIVEPOINT?	Displays the set of five entered calibration current values.	N
:GAIN <NRf>	Sets the value of the gain for the output current.	N
:OFFSet <NRf>	Sets the value of the offset for the output current.	N
:VOLTage		N
:DAC <0+NR1>	Sets the output of the output voltage D/A converter. The value range is 0 - 4095 for 12-bit operations; 0-65535 for 16-bit.	N
:FIVEPOINT <1 2 3 4 5> <0+NRf>	Sets the five voltage calibration values.	N
:FIVEPOINT?	Displays the set of five entered calibration voltage values.	N
:GAIN <NRf>	Sets the value of the gain for the output voltage.	N

Command	Description	SCPI
:OFFSet <NRf>	Sets the value of the offset for the output voltage.	N
:PROTection		N
:CALCulate	Calculates the value of the gain and offset for output overvoltage protection. This takes more than 30 seconds to complete. Use *ESE 1 and a serial poll to detect the completed operation.	N
:DAC <0+NR1>	Sets the output of the output overvoltage protection D/A converter. The value range is 0 – 4095 for 12-bit operations; 0-65535 for 16-bit.	N
:GAIN <NRf>	Sets the value of the gain for the output overvoltage protection.	N
:OFFSet <NRf>	Sets the value of the offset for the output overvoltage protection.	N
:STORe	Stores the calibration constants in non-volatile memory.	N
:UNLock <string>	Sets the non-volatile memory available to store calibration constants. The access string is "6867".	N

3.6 MEASURE SCPI COMMAND SUBSYSTEM

3.6.1 MEASURE SCPI COMMAND SUMMARY

```

MEASure[n]
  :CURRent?
  :CURRent
    :AVERage <value>
    :AVERage?
  :VOLTage?
  :VOLTage
    :AVERage <value>
    :AVERage?

```

3.6.2 MEASURE SCPI COMMAND REFERENCE

Command	Description	SCPI
MEASure[n]	Measure subsystem. n = 1-31. The default channel is 1.	C
:CURRent?	Returns the floating point value of the DC output current in amps.	C
:CURRent		
:AVERage <value>	Enter a value of 1 to 5 to set the number of readings to average together when returning the current value from the MEAS:CURR? command. This function reduces noise in the readback readings. The (default) value of 1 provides the fastest response time, but the noisiest readings. Available for DLM600 Series firmware versions 1.08 and later.	—
:AVERage?	Returns the number 1 to 5 to indicate the last set number of readings to average together when taking a current reading. Available for DLM600 Series firmware versions 1.08 and later.	—
:VOLTage?	Returns the floating point value of the DC output voltage in volts.	C
:VOLTage		
:AVERage <value>	Enter a value of 1 to 5 to set the number of readings to average together when returning the voltage value from the MEAS:VOLT? command. This function reduces noise in the readback readings. The (default) value of 1 provides the fastest response time, but the noisiest readings. Available for DLM600 Series firmware versions 1.08 and later.	—
:AVERage?	Returns the number 1 to 5 to indicate the last set number of readings to average together when taking a voltage reading. Available for DLM600 Series firmware versions 1.08 and later.	—

3.7 OUTPUT SCPI COMMAND SUBSYSTEM

3.7.1 OUTPUT SCPI COMMAND SUMMARY

OUTPut[n]

```

:ISOLation <boolean>
:POLarity <NORM/0/OFF|INV/1/ON>
:PROTection
    :DELay <0+NRf>
    :FOLD <0|1|2>
:SENSe <boolean>
:STATe <boolean>
:TRIPped?

```

3.7.2 OUTPUT SCPI COMMAND REFERENCE

Command	Description	SCPI
OUTPut[n]	Output subsystem. n = 1-31. The default channel is 1.	C
:ISOLation <boolean>	Sets the rear panel isolation relay control signal ON or OFF. Valid arguments are 1/ON or 0/OFF.	N
:POLarity <NORM/0/OFF INV/1/ON>	Changes the state of the polarity relay. This command requires that the isolation relay be open beforehand. If the isolation relay is closed when this command is attempted, the state of the polarity relay will not change, and an error message will be generated.	
:PROTection		N
:DELay <0+NRf>	Sets the programmable time delay executed by the supply before reporting output protection conditions after a new output voltage or current is specified.	N
:FOLD <0 1 2>	Sets the foldback (program down) mode of the supply. Valid arguments are 0 (OFF or do nothing, do not program down to zero), 1 (program down to zero upon entering constant-voltage mode), or 2 (program down to zero upon entering constant-current mode).	N
:SENSe <boolean>	Sets the sense relay signal open or close. Valid arguments are 1/ON or 0/OFF.	N
:STATe <boolean>	Sets the output to zero or the programmed value; opens or closes the isolation relay. Valid arguments are 1/ON or 0/OFF. *RST state value is ON. CAUTION: Ensure that suitable delays are incorporated to preclude hot switching of the isolation relay.	C
:TRIPped?	Returns the integer value 1 (TRIPPED) or 0 (UNTRIPPED) state of the output.	N

3.8 SOURCE SCPI COMMAND SUBSYSTEM

3.8.1 SOURCE SCPI COMMAND SUMMARY

```

SOURce[n]
  :CURRent
    [:LEVel]
      [:IMMEDIATE]
        [:AMPLitude] <0+NRf>
      :TRIGgered
        :CLEar
          [:AMPLitude] <0+NRf>
    :LIMit
      [:AMPLitude] <0+NRf>
  :RAMP <0+NRf> <0+NRf>
    :ABORt
    :ALL?
    :TRIGgered <0+NRf> <0+NRf>
:ONLine?
:STATus
  :BLOCk?
  :REGister?
:TIMEout?
:VOLTage
  [:LEVel]
    [:IMMEDIATE]
      [:AMPLitude] <NRf>
    :TRIGgered
      :CLEar
        [:AMPLitude] <NRf>
  :LIMit
    [:AMPLitude] <NRf>
  :PROTection
    [:LEVel] <NRf>
    :TRIPped?
    :STATe?
  :RAMP <NRf> <0+NRf>
    :ABORt
    :ALL?
    :TRIGgered <NRf> <0+NRf>

```

3.8.2 SOURCE SCPI COMMAND REFERENCE

Command	Description	SCPI
SOURce[n]	Source subsystem. n = 1-31. The default channel is 1.	C
:CURRent	Sets the output current in amps (default) or in milliamps.	C
[:LEVel]	Sets the output current in amps (default) or in milliamps.	C
[:IMMEdiate]	Sets the output current in amps (default) or in milliamps.	C
[:AMPLitude] <0+NRf>	Sets the output current in amps (default) or in milliamps.	C
:TRIGgered	Sets the value of the output current to be implemented by the trigger.	C
:CLEar	Clears the trigger mode.	
[:AMPLitude] <0+NRf>	Sets the value of the output current to be implemented by the trigger.	C
:LIMit	Sets an upper soft limit on the programmed output current for the supply.	C
[:AMPLitude] <0+NRf>	Sets an upper soft limit on the programmed output current for the supply.	C
:RAMP <0+NRf> <0+NRf>	Sets the output current to ramp from the present value to the specified value (first argument) in the specified time (second argument). See Ramp Function description below.	N
:ABORt	Aborts ramping and clears trigger mode.	
:ALL?	Returns the ramping status of all channels.	
:TRIGgered <0+NRf> <0+NRf>	Sets the output current to ramp from the present value to the specified value (first argument) in the specified time (second argument) upon the trigger command. See Ramp description below.	N
:ONLine?	Returns the integer value 1 (ONLINE) or 0 (OFFLINE) of the channel online status.	N
:STATus		
:BLOCk?	Returns the block of data critical to the status of the channel: 1) channel number 2) online status 3) status flags register (see table below) 4) status register (see sect. 5.2.2) 5) accumulated status (see sect. 5.2.2) 6) fault mask register (see sect. 5.2.2) 7) fault register (see sect. 5.2.2) 8) error register (see sect. 5.2.3) 9) model serial number 10) model voltage 11) model current 12) model over-voltage	N

Command	Description	SCPI
	13) output voltage DAC gain 14) output voltage DAC offset 15) output current DAC gain 16) output current DAC offset 17) output voltage protection DAC gain 18) output voltage protection DAC offset 19) voltage measurement ADC gain 20) voltage measurement ADC offset 21) current measurement ADC gain 22) current measurement ADC offset 23) model string 24) OVP calibrated Each value is separated by commas.	
:REGister?	Returns the integer value of the status register.	N
:TIMEout?	Returns the integer value 1 (timeout since last query) or 0 (no timeout) of the timeout status of the channel.	N
:VOLTage	Sets the output voltage of the supply in volts (default) or in millivolts. *See note on page 3-20.	C
[:LEVel]	Sets the output voltage of the supply in volts (default) or in millivolts. *See note on page 3-20.	C
[:IMMEDIATE]	Sets the output voltage of the supply in volts (default) or in millivolts. *See note on page 3-20.	C
[:AMPLitude] <NRf>	Sets the output voltage of the supply in volts (default) or in millivolts. *See note on page 3-20.	C
:TRIGgered	Sets the value of the output voltage to be implemented by the trigger. For DLM600 Series firmware versions 1.07 and later, the polarity relay must be in the correct position per the algebraic sign of the voltage to be triggered. The state of the polarity relay may be set using the OUTP:POL <NORM INV> command if it is not already in the correct position. <i>Do this before the trigger command is issued.</i> For DLM600 Series firmware versions 1.06 and earlier, the algebraic sign of the trigger voltage determines the state of the polarity relay <i>before</i> the voltage is triggered. Therefore, the user load could be exposed to an unintended reverse polarity voltage if the pre-trigger voltage had an opposite algebraic sign from the trigger voltage. For a pre-trigger voltage of zero, the above consideration is not an issue.	C
:CLEar	Clears the trigger mode.	

Command	Description	SCPI
[:AMPLitude] <NRf>	<p>Sets the value of the output voltage to be implemented by the trigger. For DLM600 Series firmware versions 1.07 and later, the polarity relay must be in the correct position per the algebraic sign of the voltage to be triggered. The state of the polarity relay may be set using the OUTP:POL <NORM INV> command if it is not already in the correct position. <i>Do this before the trigger command is issued.</i></p> <p>For DLM600 Series firmware versions 1.06 and earlier, the algebraic sign of the trigger voltage determines the state of the polarity relay <i>before</i> the voltage is triggered. Therefore, the user load could be exposed to an unintended reverse polarity voltage if the pre-trigger voltage had an opposite algebraic sign from the trigger voltage. For a pre-trigger voltage of zero, the above consideration is not an issue.</p>	C
:LIMit	Sets the upper soft limit on the programmed output voltage.	C
[:AMPLitude] <NRf>	Sets the upper soft limit on the programmed output voltage.	C
:PROTection	Sets the overvoltage protection trip point in volts (default) or in millivolts.	C
[:LEVel] <NRf>	Sets the overvoltage protection trip point in volts (default) or in millivolts.	C
:TRIPped?	Returns the integer value 1 (TRIPPED) or 0 (UNTRIPPED) state of the overvoltage protection.	C
:STATe?	Returns the integer value 1 (ON) or 0 (OFF) state of the overvoltage protection.	C
:RAMP <NRf> <0+NRf>	Sets the output voltage to ramp from the present value to the specified value (first argument) in the specified time (second argument). See Ramp Function description below.	N
:ABORt	Aborts ramping and clears trigger mode.	
:ALL?	Returns the ramping status of all channels.	
:TRIGgered <NRf> <0+NRf>	Sets the output voltage to ramp from the present value to the specified value (first argument) in the specified time (second argument) upon the trigger command. See description of the Ramp Function below.	N

***Note:** For DLM600 Series firmware versions 1.07 and later, the algebraic sign of the voltage value must match the state of the polarity relay, otherwise an error message will be generated, and the voltage command will be ignored. If the voltage value entered is positive, then the polarity relay must be in the NORM state (query the state of the polarity relay using the OUTP:POL? query command). If the voltage value entered is negative, then the polarity relay must be in the INV state. For DLM600 Series firmware versions 1.06 and earlier, the algebraic sign caused the

polarity relay to change automatically to the matching state. This automatic change in the polarity relay state is no longer supported in firmware versions 1.07 and later. To change the state of the polarity relay, use the `OUTP:POL <INV | norm>` command (when the isolation relay is open). For DCS Series supplies, the polarity relay still automatically follows the algebraic sign.

3.8.3 THE RAMP FUNCTION

The ramp function allows the user to transition from one voltage or current to another linearly in a specified time period (100 ms - 99 sec with 100 ms programming resolution). The ramp-upon-trigger function may be used to program different ramping parameters for several units then trigger them all to begin their ramps at the same time. A unit may ramp only voltage or current, not both at a given time. For example, `SOUR:VOLT:RAMP:TRIG 1 1` followed by `SOUR:CURR:RAMP:TRIG 2 2` will cause the unit to ramp only the output current to 2 amps in 2 seconds upon the `TRIG0:RAMP` command.

Voltage ramping to a higher voltage requires a programmed current of at least 20% of the full scale value. Settings less than 20% will significantly lengthen the ramp time due to charging of the large capacitance in the output section of the power supply.

Voltage ramping to a lower voltage requires an appropriate resistive load. The discharge rate of the large capacitance in the output section of the power supply, plus other user capacitance, significantly lengthens the ramp time.

Current ramping requires an appropriate resistive load.

Note: *On DCS and PRO-T models, the Reading of Voltage or Current during Ramping will extend Ramp Time.*

Table 3-7 SOURce[n]:STATus:BLOCK? "Status Flags" Register

Bit	Hex Value	Name	Description
0	0x001	remote mode	Remote mode was selected.
1	0x002	polarity signal	Negative voltage programmed. Polarity relay signal is on.
2	0x004	Not Used	
3	0x008	Not Used	
4	0x010	EEPROM	The EEPROM is locked.
5	0x020	trip occurred	Either an OV or OT trip occurred.
6	0x040	sense signal	Sense relay signal is on.
7	0x080	isolation signal	Isolation relay signal is on.
8	0x100	hold	Voltage and current output waiting for trigger.
9	0x200	fold	Foldback protection is enabled.
10	0x400	Not Used	
11	0x800	output	Output is on.

3.9 STATUS SCPI COMMAND SUBSYSTEM

3.9.1 STATUS SCPI COMMAND SUMMARY

```

STATus[n]
  :OPERation
    :CONDition?
    :ENABle <0+NR1>
    :EVENT?
  :PRESet
  :PROTection
    :CONDition?
    :ENABle <0+NR1>
    :EVENT?
    :SELEct <0+NR1>
  :QUESTionable
    :CONDition?
    :ENABle <0+NR1>
    :EVENT?

```

3.9.2 STATUS SCPI COMMAND REFERENCE

Command	Description	SCPI
STATus[n]	Status subsystem. n = 1-31. The default channel is 1.	C
:OPERation		C
:CONDition?	Returns the integer value of the Operation Condition Register. The query is supported but will always return "0" indicating operational condition.	C
:ENABle <0+NR1>	Sets the enable mask of the Operation Event Register allowing true conditions to be reported in the summary bit of the Operation Condition Register. Values are written and queried but have no effect on the Operation Condition Register.	C
:EVENT?	Returns the integer value of the Operation Event Register. This query is supported but always returns a value of "0" indicating operational condition.	C
:PRESet	Sets the enable mask of the Operation Event Register and the Questionable Event Register to all 1's.	C

Command	Description	SCPI
:PROTection		C
:CONDition?	Returns the integer value of the Protection Condition Register. Used to read the status of the power hardware. See section 3.2.3 for a detailed table of the various bits that make up this register.	C
:ENABle <0+NR1>	Sets the enable mask of the Protection Event Register, which allows true conditions to be reported in the summary bit of the Protection Condition Register.	C
:EVENT?	Returns the integer value of the Protection Event Register.	C
:SELEct <0+NR1>	This command provides a means for selecting which fault bits from the protection event register (also called the fault register and readable using the STAT:PROT:EVENT? command) are able to set the protection event flag bit in the SCPI status byte (readable using the *STB? command). It defaults to value 255 at power-on time, and never changes unless intentionally programmed to a new value. Available in the DLM600 version of the M130 GPIB or Ethernet option with firmware version 1.05 or later. Not available in the DCS.	N
:SELEct?	Queries the last selection value programmed.	N
:QUESTionable		C
:CONDition?	Returns the integer value of the Questionable Condition Register. The query is supported but will always return "0" indicating operational condition.	C
:ENABle <0+NR1>	Sets the enable mask of the Questionable Event Register allowing true conditions to be reported in the summary bit of the Questionable Condition Register. Values are written and queried but have no effect on the Questionable Condition Register.	C
:EVENT?	Returns the integer value of the Questionable Event Register. This query is supported but always returns a value of "0", indicating operational condition.	C

3.10 SYSTEM SCPI COMMAND SUBSYSTEM

3.10.1 SYSTEM SCPI COMMAND SUMMARY

SYSTem

:ERRor?
:FAULt?
:VERsion?

SYSTem[n]

:LOCAL <boolean>
:LOCLOUT <boolean>
:SLAVEBAUD <NRf>
:SLAVEBAUD?
:UPGRADE
:NET
:AUTOIP <boolean>
:AUTOIP?
:DESC <string>
:DESC?
:DHCPMODE <boolean>
:DHCPMODE?
:DNS <string>
:DNS?
:GATE <string>
:GATE?
:HOST <string>
:HOST?
:IP <string>
:IP?
:LANLED BLINKON
:LANLED BLINKOFF
:LANLED?
:MAC?
:MASK <string>
:MASK?
:NETBUTTON <string>
:PINGRESP <boolean>
:PINGRESP?
:PORT <NRf>
:PORT?
:PRICONF <integer>
:PRICONF?
:SECCONF <integer>
:SECCONF?
:TERM <NRf>
:TERM?

3.10.2 SYSTEM SCPI COMMAND REFERENCE

Command	Description	SCPI
SYSTem	System subsystem.	C
:ERRor?	Queries Error Queue for next error/event entry (first in, first out). Entries contain an error number and descriptive text. A 0 return value indicates no error occurred; negative numbers are reserved by SCPI. The maximum return string length is 255 characters. The queue holds up to 10 error/entries. All entries are cleared by the *CLS command.	C
:FAULt?	Returns four numeric values separated by commas for the four system fault registers. See System Fault Registers below (e.g., 1, 1, 2, 4 indicates ch 1, 9, 18, and 27 each have at least one fault). Response: <Fault1–8>, <Fault9–16>, <Fault17–24>, <Fault25–31>	N
:VERsion?	Returns a numeric value corresponding to the SCPI version number for which the instrument complies. The response is in the format YYYY.V where the Y's represent the year and V represents the approved version number for that year (e.g., 1995.0)	C
SYSTem[n]	System [channel number]	
:LOCAL	SYST[N]:LOCAL <ON OFF> is a special purpose programming command that may be used to cause source [N] to be set to the local state or to the remote state. This command has two noteworthy circumstances under which it may prove necessary. The first case involves using RS232 to communicate with the supply, since the normal GPIB or Ethernet mechanisms for transition between local and remote and back again do not exist when using RS232. The other case is when the REMOTE/LOCAL switch S1-1 is placed in the ON position—thereby disabling the GPIB or Ethernet mechanism for transition from remote to local. The SYST[N]:LOCAL ON command provides a means for the system computer to force source [N] to the local state. Also, the SYST[N]:LOCAL? query command is available to examine the local-remote state of the supply. And the command SYST[N]:LOCAL OFF may be used to force supply [N] to the remote state.	N

Command	Description	SCPI
:LOCLOUT	<p>The SYST[N]:LOCLOUT <0 1 OFF ON> command provides a means of controlling the local lockout functionality that is an alternative to the low level GPIB or Ethernet LLO command. A source number may be specified with this command, thereby allowing selective disabling of the front panel of a selected source.</p> <p>In contrast, using the GPIB or Ethernet LLO low level command causes the master supply, and all attached online M131 slaves, to be placed into the local lockout state. To place the master and all online M131 slaves into the local lockout state using the SYST[n]:LOCAL:LOCKOUT command, specify the source number of 0.</p> <p>To place only one slave into the local lockout state, specify that slave in the command. For example, if the slave is source 3, use the command: SYST3:LOCAL:LOCKOUT 1.</p>	
:SLAVEBAUD?	Returns the baud rate for the slave.	
:UPGRADE	Forces slave to jump to its boot loader.	
:NET	Network device	
:AUTOIP <boolean>	<p>Sets the network Auto IP mode in the Primary configuration without affecting the Secondary configuration..</p> <p>0 = disable AutoIP; 1 = enable AutoIP</p>	
:AUTOIP?	<p>Returns 1 if AutoIP is enabled in the Primary configuration.</p> <p>Returns 0 if AutoIP is disabled in the Primary configuration.</p>	
:DESC <string>	Set the network Description, a 64 character alphanumeric string	
:DESC?	Returns the network Description.	
:DHCPMODE <boolean>	<p>Sets the network DHCP Mode in the Primary configuration without affecting the Secondary configuration.</p> <p>0 = disable DHCP; 1 = enable DHCP</p>	
:DHCPMODE?	<p>Returns 1 if DHCP Mode is enabled in the Primary configuration.</p> <p>Returns 0 if DHCP mode is disabled in the Primary configuration.</p>	
:DNS <string>	Sets the network DNS IP address for the device. String is in the format "NNN.NNN.NNN.NNN" where "NNN" = 0 through 255, inclusive.	
:DNS?	Returns the network DNS address for the device.	

Command	Description	SCPI
:GATE <string>	Sets the network gateway IP address for the device. String is in the format "NNN.NNN.NNN.NNN" where "NNN" = 0 through 255, inclusive.	
:GATE?	Returns the network gateway address for the device.	
:HOST <string>	Set the network Host Name, a 15-character alphanumeric string.	
:HOST?	Returns the network Host Name, a 15 character alphanumeric string.	
:IP <string>	Sets the Primary configuration to STATICIP mode and sets the network IP address for the device. String is in the format "NNN.NNN.NNN.NNN" where "NNN" = 0 through 255, inclusive.	
:IP?	Returns two IP addresses: the first is the IP address set to be used when the system boots up; the second is the IP address presently in use by the power supply. (The first address will either be 0.0.0.0. if the Primary configuration is DHCP or DHCP+AUTOIP, or it will be the static IP last specified).	
:LANLED BLINKON	Causes LANLED to blink.	
:LANLED BLINKOFF	Causes LANLED to stop blinking.	
:LANLED?	Returns blink state of the LAN LED: 0 – not blinking; 1 – blinking.	
:MAC?	Returns the network MAC address. xx:xx:xx:xx:xx:xx (Hexadecimal digit pairs)	
:MASK <string>	Set the network Subnet Mask for the device. String is in the format "NNN.NNN.NNN.NNN" where "NNN" = 0 through 255, inclusive.	
:MASK?	Returns the network Subnet Mask for the device.	
:NETBUTTON <string>	Returns configuration parameters to factory default. (Software equivalent of pressing the Reset switch on the rear panel of the power supply). You must cycle the power to effect the change. The access string is "6867."	
:PINGRESP <boolean>	Set ping response: 1 = unit responds to ping (response enabled). 0 = ping response is not enabled.	
:PINGRESP?	Returns 1 if ping response is enabled. Returns 0 if ping response is not enabled.	

Command	Description	SCPI
:PORT <NRf>	Set the network TCP/IP socket listening port. Valid values are 1025 to 65535.	
:PORT?	Returns the network TCP/IP socket listening port.	
:PRICONF <integer>	Sets Primary IP configuration. 0 = DHCP; 1 = DHCPAUTOIP; 2 = STATICIP	
:PRICONF?	Returns currently set Primary IP configuration 0 = DHCP; 1 = DHCPAUTOIP; 2 = STATICIP	
:SECCONF <integer>	Sets Secondary IP configuration. 0 = DHCP; 1 = DHCPAUTOIP; 2 = STATICIP	
:SECCONF?	Returns currently set Secondary IP configuration. 0 = DHCP; 1 = DHCPAUTOIP; 2 = STATICIP	
:TERM <NRf>	Set the return string terminators to be used by the device. The valid range is 1-4. Values indicate the following terminator(s): 1 = 0x0d only (CR), 2 = 0x0a only (LF), 3 = 0x0d 0x0a (CR LF), 4 = 0x0a 0x0d (LF CR)	
:TERM?	Returns the string terminators to be used by the device.	

Table 3-8 System Fault Registers

Bit Position	Bit Weight	Fault1–8	Fault9–16	Fault17–24	Fault25–31
7	128	Channel 8	Channel 16	Channel 24	not used
6	64	Channel 7	Channel 15	Channel 23	Channel 31
5	32	Channel 6	Channel 14	Channel 22	Channel 30
4	16	Channel 5	Channel 13	Channel 21	Channel 29
3	8	Channel 4	Channel 12	Channel 20	Channel 28
2	4	Channel 3	Channel 11	Channel 19	Channel 27
1	2	Channel 2	Channel 10	Channel 18	Channel 26
0	1	Channel 1	Channel 9	Channel 17	Channel 25

The M130 provides four System Fault Registers to allow the user to monitor the fault status of a multiple-channel system. For example, the user may poll these registers to quickly determine which channel generated an enabled GPIB or Ethernet service request.

The SYStem:FAULt? query returns 4 numeric values separated by commas. Each value is the decimal equivalent of the total bit weights for that System Fault Register as described in the table above.

3.11 TRIGGER SCPI COMMAND SUBSYSTEM

3.11.1 TRIGGER SCPI COMMAND SUMMARY

TRIGger[n]
 :ABORt
 :RAMP
 :TYPE <1|2|3>

3.11.2 TRIGGER SCPI COMMAND REFERENCE

Command	Description	SCPI
TRIGger[n]	Trigger subsystem. N = 0, 1-31. The default channel is 1. A value of n = 0 will program all channels.	C
:ABORt	Clears all settings of voltage and current upon trigger.	N
:RAMP	Implements current or voltage ramping function previously programmed by the SOURce:CURRent:RAMP or SOURce:VOLTag:e:RAMP commands.	N
:TYPE<1 2 3>	Implements voltage and current values previously programmed by the SOURce:CURRent:LEVel:TRIGger and SOURce:VOLTag:e:LEVel:TRIGger commands. Valid arguments are 1 (Voltage), 2 (Current), or 3 (Both).	N

3.12 EXAMPLES OF USING THE SCPI COMMANDS

The following examples demonstrate programming a power supply to control and to readback the output using the SCPI commands. The maximum voltage and current output is dependent on the particular model. The examples list only the SCPI commands; the code required to send the commands is dependent on the type of language you are using (e.g., C or BASIC) and GPIB or Ethernet hardware (e.g., National Instruments).

EXAMPLE: Program a unit with no load at the output to 5 VDC @ 1A, and verify the output.

```
// Use SYST:ERR? after each command to verify no programming errors.
// turn on the unit.
*CLS // clear the unit to its power-on default settings.
*RST // reset the unit.
SOUR:CURRE 1.0 // program output current to 1.0 A.
SOUR:CURRE? // confirm the output current setting (response: 1.0).
SOUR:VOLT 5.0 // program output voltage to 5.0 VDC.
SOUR:VOLT? // confirm the output voltage setting (response: 5.0).
MEAS:CURRE // measure the actual output current (response: ~ 0.0 with no load
on output).
MEAS:VOLT? // measure the actual output voltage (response: ~ 5.0).
```

EXAMPLE: Program a unit with no load at the output to generate a GPIB service request or Ethernet OVP Fault upon an overvoltage protection trip condition (must use GPIB or Ethernet, not RS-232).

```
// Use SYST:ERR? after each command to verify no programming errors.
// Turn on the unit.
*CLS // clear the unit to its power-on default settings.
*RST // reset the unit.
SOUR:VOLT:PROT 4.0 // program the OVP trip point to 4.0 VDC.
SOUR:VOLT:PROT? // confirm the OVP trip point setting (response: 4.0).
SOUR:CURRE 1.0 // program output current to 1.0 A.
SOUR:VOLT 3.0 // program output voltage to 3.0 VDC.
STAT:PROT:ENABLE 8 // program the unit to report OVP trip.
STAT:PROT:ENABLE? // confirm that OVP fault is enabled (response: 8).

STAT:PROT:EVENT? // confirm no faults occurred (response: 0).
// confirm that the OVP LED is not active.
SOUR:VOLT 7.0 // program output voltage to 7.0 VDC - cause OVP trip!
// confirm that OVP LED is active.
```

EXAMPLE: Program a unit with no load at the output to change its output voltage and current to 5 VDC @ 1A at the same time.

```
// Use SYST:ERR? after each command to verify no programming errors.
// turn on the unit.
*CLS // clear the unit to its power-on default settings.
*RST // reset the unit.
SOUR:CURRE:TRIG1.0 // program output current to 1.0 A upon trigger.
SOUR:CURRE:TRIG? // confirm output current set to 1.0 A upon trigger.
SOUR:VOLT:TRIG5.0 // program output voltage to 5.0 VDC upon trigger
SOUR:VOLT:TRIG? // confirm output current set to 5.0 VDC upon trigger.
MEAS:CURRE? // measure the actual output current (response: 0.0).
MEAS:VOLT? // measure the actual output voltage (response: 0.0).
TRIG:TYPE 3 // trigger the unit to implement curr and volt programming.
MEAS:CURRE? // measure the actual output current (response: ~ 0. 0 with no
// load on output).
MEAS:VOLT? // measure the actual output voltage (response: ~ 5.0).
TRIG:ABORT // turn off trigger mode.
```

EXAMPLE: Program a unit with no load at the output to ramp its output voltage from 5 VDC to 25 VDC in 30 seconds.

Note: *The maximum output voltage is dependent upon the power supply rating.*

```
// Use SYST:ERR? after each command to verify no programming errors.
// turn on the unit.
*CLS // clear the unit to its power-on default settings.
*RST // reset the unit.
SOUR:CURRE 33.0 // program output current to 33.0 A.
SOUR:VOLT 5.0 // program output voltage to 5.0 VDC.
SOUR:VOLT:RAMP 25.0 30.0 // program voltage to ramp from the present
// value (5.0 VDC) to 25.0 VDC in 30 seconds.
```

EXAMPLE: Program a unit with the output shorted to ramp its output current from 5A to 25A in 30 seconds.

```
// Use SYST:ERR? after each command to verify no programming errors.
// turn on with no load at the output.
*CLS // clear the unit to its power-on default settings.
*RST // reset the unit.
// short the output.
SOUR:VOLT 33.0 // program output voltage to 33.0 VDC.
SOUR:CURRE 5.0 // program output current to 5.0 A.
SOUR:CURRE:RAMP 25.0 30.0 // program current to ramp from the present
// value (5.0 A) to 25.0 A in 30 seconds.
```

EXAMPLE: Program a unit with no load at the output to ramp its output voltage from 5 VDC to 25 VDC in 30 seconds upon the trigger command.

```
// Use SYST:ERR? after each command to verify no programming errors.
// turn on the unit.
*CLS // clear the unit to its power-on default settings.
*RST // reset the unit.
SOUR:CURR 33.0 // program output current to 33.0 A.
SOUR:VOLT 5.0 // program output voltage to 5.0 VDC.
SOUR:VOLT:RAMP:TRIG 25.0 30.0 // program voltage to ramp from the present
// value (5.0 VDC) to 25.0 VDC in 30 secs.
// upon the trigger command.
TRIG:RAMP // start ramp execution.
TRIG:ABORT // turn off trigger mode.
```

EXAMPLE: Program a unit to power-on and initialize to 2 VDC @ 1A with an overvoltage protection level of 3 VDC. Verify proper power-on initialization.

```
// Use SYST:ERR? after each command to verify no programming errors.
// turn on the unit.
*CLS // clear the unit to its power on default settings.
*RST // reset the unit.
CAL:INIT:CURR 1.0 // set power-on initial current to 1.0 A.
CAL:INIT:CURR? // confirm power-on initial current setting.
CAL:INIT:VOLT 2.0 // set power-on initial voltage to 2.0 VDC.
CAL:INIT:VOLT? // confirm power-on initial voltage setting.
CAL:INIT:VOLT:PROT 3.0 // set power-on initial overvoltage protection to 3.0 VDC.
CAL:INIT:VOLT:PROT? // confirm power-on initial overvoltage protection setting.
CAL:UNLOCK "6867" // unlock nonvolatile memory for calibration value storage.
CAL:STORE // store the calibration values in nonvolatile memory.
CAL:LOCK // lock nonvolatile memory for calibration value protection.
// cycle power to the unit.
// note voltage is initialized to 2.0 VDC via front panel.
SOUR:CURR? // confirm power-on initial current setting.
SOUR:VOLT? // confirm power-on initial voltage setting.
SOUR:VOLT:PROT? // confirm power-on initial overvoltage protection setting.
```

SECTION 4 CALIBRATION



WARNING

Please refer to the power supply manual for further information before performing calibration procedures. Qualified personnel who appropriately deal with attendant hazards must perform calibration. If calibration is not performed properly, functional problems could arise, requiring that the supply be returned to the factory.

4.1 INTRODUCTION

The supply is calibrated to adjust internal signal levels to correspond to the expected supply output signal levels. You must perform the calibration procedures if the power supply's programming or readback performance falls out of specification due to component aging drifts. Refer to your power supply manual to find the required calibration interval. The supply also is calibrated for output voltage programming, output current programming, output overvoltage protection programming, voltage readback, and current readback. There are 10 calibration factors (four measurement and six output).

The calibration procedures in the following sections are designed to be performed at ambient temperature of $25^{\circ}\text{C} \pm 5^{\circ}\text{C}$, after the unit has had a stable output and a stable load for at least 30 minutes.

The following test equipment is required in addition to the computer system to complete the following calibration:

- 6-digit digital voltmeter (DVM)
- current shunt rated for 110% of full output current

4.2 SETUP FOR CALIBRATION

<u>STEP</u>	<u>DESCRIPTION</u>
1.	Disconnect the power supply's AC input power.
2.	Disconnect the load from the power supply you want to calibrate.
3.	Connect the power supply for sensing at the required load point. Refer to the power supply manual for further information.
4.	Connect the DVM to the output for voltage or overvoltage calibration, or connect a current shunt rated for the full output current of the supply and the DVM for current calibration.
5.	Assure the correct primary address has been set by the rear panel switch.
6.	Set the power supply to REMOTE mode by the rear panel switch.
7.	Connect the GPIB or Ethernet controller to the power supply at the rear panel connector.
8.	Reconnect the AC input power. Turn the unit on and allow the unit to warm up for at least 30 minutes.
9.	The unit is ready for all calibration procedures, to be followed in the order presented.
10.	Once calibration is completed, new values for Last Calibration Date and Next Calibration Date may be entered. See Section 4.8.

**WARNING**

Exercise caution when using and servicing power supplies. High energy levels can be stored at the output voltage terminals on all power supplies in normal operation. In addition, potentially lethal voltages exist in the power circuit and the output connector on power supplies that are rated at 60V and over. Filter capacitors store potentially dangerous energy for some time after power is removed.

4.3 VOLTAGE PROGRAMMING CALIBRATION

The following procedures are for five-point calibration:

<u>STEP</u>	<u>DESCRIPTION</u>
--------------------	---------------------------

- | | |
|-----|---|
| 1. | Issue a *CLS[n] command. |
| 2. | Issue a *RST[n] command. |
| 3. | Program the overvoltage protection to maximum to prevent nuisance trips:

CAL[n]:OUTP:VOLT:PROT:DAC 65535 |
| 4. | Program the output current to full scale to prevent Constant-Current operation:

CAL[n]:OUTP:CURR:DAC 65535 |
| 5. | Program the output of the first calibration point by sending the following command string from the computer:

CAL[n]:OUTP:VOLT:DAC 3275 |
| 6. | Let the output settle and measure the voltage with a high precision voltmeter; this is value 1. |
| 7. | Enter the actual output voltage value of the first calibration point:

CAL[n]:OUTP:VOLT:FIVEPOINT 1 <value 1> |
| 8. | Program the output of the second calibration point by sending the following command string from the computer:

CAL[n]:OUTP:VOLT:DAC 19000 |
| 9. | Let the output settle and measure the voltage with a high precision voltmeter; this is value 2. |
| 10. | Enter the actual output voltage value of the second calibration point:

CAL[n]:OUTP:VOLT:FIVEPOINT 2 <value 2> |
| 11. | Program the output of the third calibration point by sending the following command string from the computer:

CAL[n]:OUTP:VOLT:DAC 32000 |
| 12. | Let the output settle and measure the voltage with a high precision voltmeter; this is value 3. |

13. Enter the actual output voltage value of the third calibration point:
`CAL[n]:OUTP:VOLT:FIVEPOINT 3 <value 3>`
14. Program the output of the fourth calibration point by sending the following command string from the computer:
`CAL[n]:OUTP:VOLT:DAC 45000`
15. Let the output settle and measure the voltage with a high precision voltmeter; this is value 4.
16. Enter the actual output voltage value of the fourth calibration point:
`CAL[n]:OUTP:VOLT:FIVEPOINT 4 <value 4>`
17. Program the output of the fifth calibration point by sending the following command string from the computer:
`CAL[n]:OUTP:VOLT:DAC 62250`
18. Let the output settle and measure the voltage with a high precision voltmeter; this is value 5.
19. Enter the actual output voltage value of the fifth calibration point:
`CAL[n]:OUTP:VOLT:FIVEPOINT 5 <value 5>`
20. To review entered data for five–point voltage calibration, issue the following query:
`CAL[n]:OUTP:VOLT:FIVEPOINT?`
21. Program the supply to unlock the non-volatile memory for calibration value storage:
`CAL[n]:UNLOCK "6867"`
22. Program the supply to store the calibration values in non-volatile memory:
`CAL[n]:STORE`
Allow 10 seconds for the non-volatile memory to be updated with the new calibration values.
23. Program the supply to lock the non-volatile memory for calibration value protection.
`CAL[n]:LOCK`
24. The output voltage calibration is complete. The unit may be turned off or other calibration procedures may be performed.

4.4 VOLTAGE MEASUREMENT/READBAC CALIBRATION

<u>STEP</u>	<u>DESCRIPTION</u>
--------------------	---------------------------

1. Program the overvoltage protection to maximum to prevent nuisance trips:

```
CAL[n]:OUTP:VOLT:PROT:DAC 65535
```

2. Program the output current to full scale to prevent Constant-Current operation:

```
CAL[n]:OUTP:CURR:DAC 65535
```

3. Program the output of the first calibration point to approximately 15% of full scale voltage by sending the following command string from the computer:

```
CAL[n]:OUTP:VOLT:DAC 6500
```

4. Let the output settle and measure the voltage with the meter.

5. Enter the actual voltage readback corresponding to the DAC value 6500 of the first calibration point:

```
CAL[n]:MEAS:VOLT:POINT 1 <voltage>
```

6. Program the output of the second calibration point to approximately 85% of full scale voltage by sending the following command string from the computer:

```
CAL[n]:OUTP:VOLT:DAC 57500
```

7. Let the output settle and measure the voltage with the meter.

8. Enter the actual voltage readback corresponding to the DAC value 57500 of the second calibration point:

```
CAL[n]:MEAS:VOLT:POINT 2 <voltage>
```

9. Reset the output voltage to 0 volts.

```
CAL[n]:OUTP:VOLT:DAC 0
```

10. Program the M130 to calculate the voltage readback calibration gain and offset values:

```
CAL[n]:MEAS:VOLT:CALC
```

11. Program the supply to unlock the non-volatile memory for calibration value storage:

```
CAL[n]:UNLOCK "6867"
```

12. Program the supply to store the calibration values in non-volatile memory:
CAL[n]:STORE

Allow 10 seconds for the non-volatile memory to be updated with the new calibration values.
13. Program the supply to lock the non-volatile memory for calibration value protection
CAL[n]:LOCK
14. The voltage readback calibration is complete. The unit may be turned off or other calibration procedures may be performed.

4.5 OVERVOLTAGE PROTECTION PROGRAMMING

The overvoltage protection calibration procedure requires calibrated output voltage programming and voltage readback.

<u>STEP</u>	<u>DESCRIPTION</u>
--------------------	---------------------------

- | | |
|----|---|
| 1. | Program the supply to self-calibrate the overvoltage protection:
CAL[n]:OUTP:VOLT:PROT:CALC

The overvoltage protection calibration function requires over 30 seconds. |
| 2. | Program the supply to unlock the non-volatile memory for calibration value storage:
CAL[n]:UNLOCK "6867" |
| 3. | Program the supply to store the calibration values in non-volatile memory:
CAL[n]:STORE

<i>Allow 10 seconds for the non-volatile memory to be updated with the new calibration values.</i> |
| 4. | Program the supply to lock the non-volatile memory for calibration value protection
CAL[n]:LOCK |
| 5. | The output overvoltage protection calibration is complete. The unit may be turned OFF or other calibration procedures may be performed. |

4.6 CURRENT PROGRAMMING CALIBRATION

Attach a high precision shunt between the power supply's output terminals and attach a high precision voltmeter across the shunt.

<u>STEP</u>	<u>DESCRIPTION</u>
--------------------	---------------------------

- | | |
|-----|---|
| 1. | Issue a *CLS[n] command. |
| 2. | Issue a *RST[n] command |
| 3. | Program the overvoltage protection to maximum to prevent nuisance trips:

CAL[n]:OUTP:VOLT:PROT:DAC 65535 |
| 4. | Program the output voltage to full scale to prevent Constant-Voltage operation:

CAL[n]:OUTP:VOLT:DAC 65535 |
| 5. | Program the output of the first calibration point by sending the following command string from the computer:

CAL[n]:OUTP:CURR:DAC 3275 |
| 6. | Let the output settle and measure the output current with the current shunt and the high precision voltmeter; this is value 1. |
| 7. | Enter the actual output current of the first calibration point:

CAL[n]:OUTP:CURR:FIVEPOINT 1 <value 1> |
| 8. | Program the output of the second calibration point by sending the following command string from the computer:

CAL[n]:OUTP:CURR:DAC 19000 |
| 9. | Let the output settle and measure the output current with the current shunt and the high precision voltmeter; this is value 2. |
| 10. | Enter the actual output current of the second calibration point:

CAL[n]:OUTP:CURR:FIVEPOINT 2 <value 2> |
| 11. | Program the output of the third calibration point by sending the following command string from the computer:

CAL[n]:OUTP:CURR:DAC 32000 |
| 12. | Let the output settle and measure the output current with the current shunt and the high precision voltmeter; this is value 3. |

13. Enter the actual output current of the third calibration point:
`CAL[n]:OUTP:CURR:FIVEPOINT 3 <value 3>`
14. Program the output of the fourth calibration point by sending the following command string from the computer:
`CAL[n]:OUTP:CURR:DAC 45000`
15. Let the output settle and measure the output current with the current shunt and the high precision voltmeter; this is value 4.
16. Enter the actual output current of the fourth calibration point:
`CAL[n]:OUTP:CURR:FIVEPOINT 4 <value 4>`
17. Program the output of the fifth calibration point by sending the following command string from the computer:
`CAL[n]:OUTP:CURR:DAC 62250`
18. Let the output settle and measure the output current with the current shunt and the high precision voltmeter; this is value 5.
19. Enter the actual output current of the fifth calibration point:
`CAL[n]:OUTP:CURR:FIVEPOINT 5 <value 5>`
20. To review entered data for five–point current calibration, issue the following query:
`CAL[n]:OUTP:CURR:FIVEPOINT?`
21. Program the supply to unlock the non-volatile memory for calibration value storage:
`CAL[n]:UNLOCK "6867"`
22. Program the supply to store the calibration values in non-volatile memory:
`CAL[n]:STORE`
Allow 10 seconds for the non-volatile memory to be updated with the new calibration values.
23. Program the supply to lock the non-volatile memory for calibration value protection:
`CAL[n]:LOCK`
24. The output current calibration is complete. The unit may be turned off or other calibration procedures may be performed.

4.7 CURRENT MEASUREMENT/READBCK CALIBRATION

<u>STEP</u>	<u>DESCRIPTION</u>
-------------	--------------------

- | | |
|-----|--|
| 1. | Program the overvoltage protection to maximum to prevent nuisance trips:
CAL[n]:OUTP:VOLT:PROT:DAC 65535 |
| 2. | Program the output voltage to full scale to prevent Constant-Voltage operation:
CAL[n]:OUTP:VOLT:DAC 65535 |
| 3. | Program the output of the first calibration point to approximately 15% of full scale current by sending the following command string from the computer:
CAL[n]:OUTP:CURR:DAC 6500 |
| 4. | Let the output settle and measure the current with the current shunt and the meter. |
| 5. | Enter the actual current readback corresponding to the DAC value 6500 of the first calibration point:
CAL[n]:MEAS:CURR:POINT 1 <current> |
| 6. | Program the output of the second calibration point to approximately 85% of full scale current by sending the following command string from the computer:
CAL[n]:OUTP:CURR:DAC 57500 |
| 7. | Let the output settle and measure the current with the current shunt and the meter. |
| 8. | Enter the actual current readback corresponding to the DAC value 57500 of the second calibration point:
CAL[n]:MEAS:CURR:POINT 2 <current> |
| 9. | Reset the output current to 0 amps.
CAL:OUTP:CURR:DAC 0 |
| 10. | Program the supply to calculate the current readback calibration gain and offset values:
CAL[n]:MEAS:CURR:CALC |
| 11. | Program the supply to unlock the non-volatile memory for calibration value storage:
CAL[n]:UNLOCK "6867" |

12. Program the supply to store the calibration values in non-volatile memory:
CAL[n]:STORE

Allow 10 seconds for the non-volatile memory to be updated with the new calibration values.
13. Program the supply to lock the non-volatile memory for calibration value protection
CAL[n]:LOCK
14. The current readback calibration is complete. The unit may be turned OFF or other calibration procedures may be performed.

4.8 UPDATE OF NON-VOLATILE CALIBRATION DATES

This procedure allows the user to store, in non-volatile memory, the date of the last calibration (LASTCALDATE) and the date for the next due calibration (NEXTCALDATE).

1. Program the supply with the date of the most recent calibration:
CAL[n]:MOD:LASTCALDATE <MM> <DD> <YYYY>
(e.g. CAL1:MOD:LASTCALDATE 07 31 2005)
2. Program the supply with the date of the next calibration (normally 1 year from last calibration):
CAL[n]:MOD:NEXTCALDATE <MM> <DD> <YYYY>
3. Program the supply to unlock the non-volatile memory for calibration value storage:
CAL[n]:UNLOCK "6867"
4. Program the supply to store the calibration values in non-volatile memory:
CAL[n]:STORE

Allow 10 seconds for the non-volatile memory to be updated with the new calibration values.
5. Program the supply to lock the non-volatile memory for calibration value protection
CAL[n]:LOCK
6. The unit may be turned OFF or other calibration procedures may be performed.

SECTION 5 OPERATION WITH M131 OPTION

5.1 INTRODUCTION

The following sections describe the operation of the power supply with the M131 option and how to configure the option for your application.

The M131 option enables you to use your power supply as an auxiliary unit. The master unit would be a power supply with the M130 interface option. The auxiliary unit or units share the Ethernet address or RS-232 interface with the master unit. Up to 30 auxiliary units can be controlled by the master unit.

This option can be used with the DLM600 and DCS 1kW and 3kW supplies and supports the SCPI language.

5.2 CONFIGURATION

The S1 DIP switch is accessible from the rear panel. It allows configuration of the M131 for auxiliary operation. Figure 5-1 shows an example of switch settings for the DLM600 and the DCS 3k power supplies with the M131 option, configured as an auxiliary at channel 2, in remote mode.

Note: Only the Remote/Local switch is used for Ethernet.

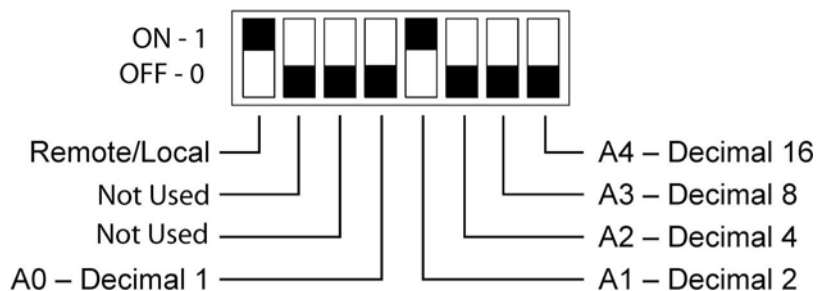

Figure 5-1. DLM600W Configuration for M131 set to Channel 2

Figure 5-2 shows an example of switch settings for the DLM600 with the M6 option and the DCS 1k and 1.2k power supplies with the M131 option, configured as an auxiliary at channel 8, in remote mode.

Note: Only the Remote/Local switch is used for Ethernet.

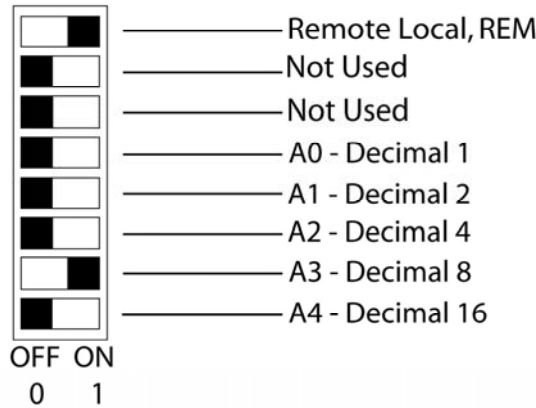

Figure 5-2. Switch Configuration for M6 or M131 set to Channel 8

Table 5-1 Definitions of S1 Switch Settings

Switch	ON	OFF
S1-1	Remote control	Local control
S1-2	Not used.	Not used.
S1-3	Not applicable. Must be OFF.	Unit operates as an auxiliary unit.
S1-4–8	Set channel number for unit in binary:	(Channels 0 and 1 see note below.)
S1-4	Binary 1 ON	Binary 1 OFF
S1-5	Binary 2 ON	Binary 2 OFF
S1-6	Binary 4 ON	Binary 4 OFF
S1-7	Binary 8 ON	Binary 8 OFF
S1-8	Binary 16 ON	Binary 16 OFF

Note: Channel numbers 0 and 1 are invalid for any auxiliary device, because the M130 implementation of the SCPI language reserves channel 0 for the “global” address to address all channels, and it reserves channel number 1 as the default number for the master channel.

5.3 SYSTEM INSTALLATION

Follow the steps below, illustrated in Figure 5-3, to install the configured M131 into your system:

1. Configure the M131 as described in the Configuration section above.
2. Connect the master unit's RS-485 output connector, J2, to the auxiliary unit's RS-485 input connector, J1, using the modular cable.
3. If there are additional auxiliary units, connect the installed auxiliary unit's RS-485 output connector, J2, to the additional auxiliary unit's RS-485 input connector, J1, using the modular cable.
4. Connect the 120 ohm resistive termination assembly to the last auxiliary unit's J2 connector.
5. Connect power to the system, power it up, and verify that the green REMOTE LED on the front panel is ON.
6. Test the link by communicating with the auxiliary unit from the master unit, using the `*IDN[n]?` command. *Note that [n] is the channel number—for example, `*IDN2?` calls channel 2. (In response to this string, the system returns the power supply model number and the firmware version.)*

NOTE: The slave baud rate is 9600.

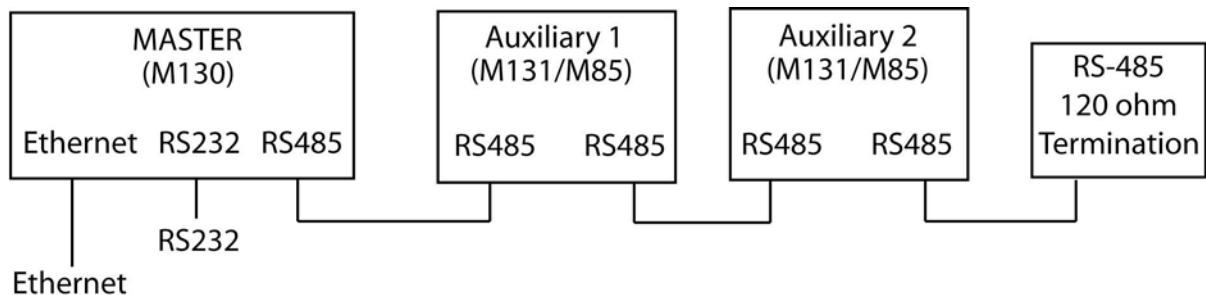

Figure 5-3. RS-485 System Interconnection with Two Auxiliaries

5.4 RS-485 INTERFACE

The RS-485 interface is accessible through the two rear-panel, 6-pin, RJ-11 connectors, J1 and J2, depicted in Figure 5-4.

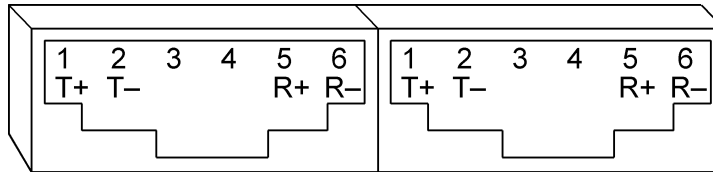

Figure 5-4. M131 Rear Panel RS-485 Connectors Pinout

5.5 PROGRAMMING THE M131 UNIT (EXAMPLE)

The following example programs the M131 unit to:

- Turn on
- Initialize to 2 VDC, at 1A
- Set overvoltage protection level at 3 VDC
- Verify proper power-on initialization
- Save and store changes.

```
// Use SYST:ERR? after each command to verify no programming errors.
// turn on the unit.
*CLS // clear the unit to its power on default settings.
*RST // reset the unit.
CAL[n]:INIT:CURR 1.0 // set power-on initial current to 1.0A.
CAL[n]:INIT:CURR? // confirm power-on initial current setting.
CAL[n]:INIT:VOLT 2.0 // set power-on initial voltage to 2.0V.
CAL[n]:INIT:VOLT? // confirm power-on initial voltage setting.
CAL[n]:INIT:VOLT:PROT 3.0 // set power-on initial overvoltage protection to 3.0V.
CAL[n]:INIT:VOLT:PROT? // confirm power-on initial overvoltage protection setting.
CAL[n]:UNLOCK "6867" // unlock nonvolatile memory for calibration value storage.
CAL[n]:STORE // store the calibration values in nonvolatile memory.
CAL[n]:LOCK // lock nonvolatile memory for calibration value protection.
// cycle power to unit.
// note voltage is initialized to 2.0 VDC via front panel.
SOUR[n]:CURR? // confirm power-on initial current setting.
SOUR[n]:VOLT? // confirm power-on initial voltage setting.
SOUR[n]:VOLT:PROT? // confirm power-on initial overvoltage protection setting.
```

INDEX

- A
- Accuracy
 - programming, 4
 - readback, 4
- C
- CALibrate[n], 3-12
- Calibration, 4-1
 - Current Measurement/Readback
 - Calibration, 4-9
 - Current Programming, 4-7
 - Current Programming Calibration, 4-7
 - Overvoltage Protection Programming
 - Calibration, 4-6
 - Setup for Calibration, 4-2
 - Voltage Measurement/Readback
 - Calibration, 4-5
 - Voltage Programming, 4-3
 - Voltage Programming Calibration, 4-3
 - Warning, 4-1, 4-2
- Calibration Dates,
 - Non-Volatile Update, 4-10
- Calibration SCPI Command
 - Reference, 3-13
 - Summary, 3-12
- Calibration SCPI Command Subsystem, 3-12
- Communication Methods, 2-13
- Configuration
 - Ethernet/Lan, 3
- Conventions, 3-9
 - [], 3-9
- E
- Error/Event Queue, 3-4
- SCPI Error Codes, 3-4
- Examples of Using SCPI Commands, 3-34
- External User Control Signal Connector
 - FAULT output signal, 2-10
 - FOLDBACK output signal, 2-10
 - ISOLATION output signal, 2-10
 - POLARITY output signal, 2-10
 - SENSE output signal, 2-10
 - SHUTDOWN TTL input signal, 2-10
 - SYNC output signal, 2-10
- External User Control Signal Connector, 2-10
 - Illustration of Open Collector, TTL Input, and Relay Output Circuits, 2-13
 - Warning, 2-13
- F
- Features, 1
- Function
 - Ramp, 3-24
- Functions
 - Programmable, 2
 - Readback, 2
- I
- IEEE-488.2 and SCPI Conformance Information, 3-8
- IEEE-488.2 Common Command Subsystem, 3-10
 - *CLS, 3-10
 - *ESE, 3-10
 - *ESR?, 3-10
 - *IDN?, 3-10
 - *OPC, 3-10
 - *RST, 3-10
 - *SRE, 3-10

- *STB?, 3-11
 - *TST?, 3-11
 - *WAI, 3-11
 - IEEE-488.2 Register Definitions, 3-1
- L
- Local Operation, 2-9
- M
- Measure SCPI Command
 - Reference, 3-16
 - Summary, 3-16
 - Measure SCPI Command Subsystem, 3-16
 - MEASure[n], 3-16
 - Multiple Source Control with the M131
 - Option, 2-32
 - RS-485 Rear Panel RJ-11 Connector
 - Pinout, 2-32
- O
- Operation Status and Questionable Status
 - Registers, 3-4
 - Operation, M131, 5-1
 - Output SCPI Command
 - Reference, 3-18
 - Summary, 3-18
 - Output SCPI Command Subsystem, 3-18
 - OUTPut[n], 3-18
- P
- Parameter Definitions, 3-8
 - 0+NR1, 3-8
 - 0+NRf, 3-8
 - boolean, 3-8
 - NR1, 3-8
 - NRf, 3-8
 - string, 3-8
 - Power-On Conditions, 2-9
 - Default, 2-9
 - Programming
 - accuracy, 4
 - resolution, 4
 - Protection Event Status Register, 3-3
- Q
- Queries, 3-9
- R
- Ramp Function, 3-24
 - Ramping
 - Description, 3-24
 - Raw Socket Interface, 2-13
 - Readback
 - accuracy, 4
 - resolution, 4
 - Rear Panel Configuration Switch
 - Remote/Local Selection, 2-9
 - Rear Panel Configuration Switch S1, 2-8
 - Register Definitions
 - IEEE-488.2, 3-1
 - Remote Operation, 2-9
 - Remote Programming via RS-232, 2-31
 - Resolution
 - programming, 4
 - readback, 4
 - RS-485 Interface, 5-4
- S
- SCPI
 - Conformance Information, 3-8
 - Error Codes, 3-4
 - Operation Status, 3-4
 - Parameter Definitions, 3-8
 - Protection Condition/Event Status
 - Registers, 3-3
 - Questionable Status Registers, 3-4
 - Standard Event Status Register (ESR), 3-2
 - Status Byte, 3-1
 - SCPI Command Operation, 3-1
 - CALibrate[n], 3-12
 - MEASure[n], 3-16
 - OUTPut[n], 3-18
 - Warning, 3-19
 - SOURce[n], 3-19
 - STATus[n], 3-25
 - TRIGgered[n], 3-32
 - SCPI Commands
 - examples of using, 3-34
 - Serial Poll Operation, 3-6
 - Setup Procedure, 2-1
 - Source SCPI Command
 - Reference, 3-21
 - Summary, 3-19
 - Source SCPI Command Subsystem, 3-19
 - SOURce[n], 3-19
 - Specifications, 3
 - Standard Event Status Register (ESR), 3-2

- Status Byte, 3-1
 - Status Flags Register, 3-24
 - Status SCPI Command
 - Reference, 3-25
 - Summary, 3-25
 - Status SCPI Command Subsystem, 3-25
 - STATus[n], 3-25
 - Switch Settings, M131, 5-2
 - Synchronization Pulse, 2-10
 - System Installation, M131, 5-3
 - System SCPI Command
 - Reference, 3-29
 - Summary, 3-28
 - System SCPI Command Subsystem, 3-28
- T
- Trigger SCPI Command
 - Reference, 3-32
 - Summary, 3-32
 - Trigger SCPI Command Subsystem, 3-32
 - TRIGgered[n], 3-32
- U
- Units, 3-9
- W
- Web Server, 2-13
 - Configuration page, 2-17
 - Home page, 2-15
 - Login window, 2-15
 - Security page, 2-24
 - Settings page, 2-20
 - Slave Info page, 2-29
 - Status page, 2-22
 - Troubleshooting, 2-29